

**DS-2CD2955G0-IS(U)**  
**5 MP Fisheye Network Camera**

114-729



- High quality imaging with 5 MP resolution
- Efficient H.265+ compression technology
- 180° fisheye view
- Clear imaging against strong back light due to 120 dB true WDR technology
- Audio and alarm interface available

## ▪ Specification

Camera	
Image Sensor	1/2.7" Progressive Scan CMOS
Max. Resolution	2560 × 1920
Shutter Time	1/3 s to 1/100,000 s
Min. Illumination	Color: 0.017 Lux @ (F2.25, AGC ON), B/W: 0 Lux with IR
Day & Night	IR cut filter
Lens	
Lens Type	Fixed focal lens, 1.05 mm
Focal Length & FOV	1.05 mm, horizontal FOV: 180°, vertical FOV: 180°, diagonal FOV: 180°
Lens Mount	M12
Focus	Fixed
Iris Type	Fixed
Aperture	F2.25
Depth of Field	0.1 m to ∞
DORI	
DORI	D: 21 m, O: 8 m, R: 4 m, I: 2 m
Illuminator	
Supplement Light Type	IR
Supplement Light Range	Up to 8 m
Smart Supplement Light	Yes
IR Wavelength	850 nm
Video	
Main Stream	50 Hz: 25 fps (2560 × 1920, 2048 × 1536, 1280 × 960) 60 Hz: 30 fps (2560 × 1920, 2048 × 1536, 1280 × 960)
Sub-Stream	50 Hz: 25 fps (640 × 480) 60 Hz: 30 fps (640 × 480)
Video Compression	Main stream: H.265+/H.265/H.264+/H.264, Sub-stream: H.265/H.264/MJPEG
Video Bit Rate	32 Kbps to 16 Mbps
H.264 Type	Baseline Profile, Main Profile, High Profile
H.265 Type	Main Profile
Region of Interest (ROI)	1 fixed region for main stream
Fisheye Display	
Mount Type	Support wall/table/ceiling mounting
Audio	
Audio Type	Mono sound
Audio Compression	G.711ulaw/G.711alaw/G.722.1/G.726/MP2L2/PCM/AAC-LC
Audio Bit Rate	64 Kbps (G.711 ulaw/G.711 alawm/16 Kbps (G.722.1))/16 Kbps (G.726)/32~160 Kbps (MP2L2)/16~64Kbps (AAC-LC)
Audio Sampling Rate	8 kHz/16 kHz
Environment Noise Filtering	Yes
Network	
Protocols	TCP/IP, ICMP, HTTP, HTTPS, FTP, DHCP, DNS, DDNS, RTP, RTSP, RTCP, PPPoE, NTP, UPnP, SMTP, SNMP, IGMP, 802.1X, QoS, IPv6, Bonjour, IPv4, UDP, SSL/TLS

Simultaneous Live View	Up to 6 channels
API	Open Network Video Interface (Profile S, Profile T, Profile G), ISAPI
User/Host	Up to 32 users 3 user levels: administrator, operator, and user
Client	iVMS-4200, Hik-Connect, Hik-Central
Security	Password protection, complicated password, HTTPS encryption, IP address filter, Security Audit Log, basic and digest authentication for HTTP/HTTPS, TLS 1.1/1.2, WSSE and digest authentication for Open Network Video Interface
Web Browser	Plug-in required live view: IE 10+, Local service: Chrome 57.0+, Firefox 52.0+
Network Storage	NAS (NFS, SMB/CIFS)
<b>Image</b>	
Image Settings	Rotate mode, saturation, brightness, contrast, sharpness, white balance, adjustable by client software or web browser
Day/Night Switch	Day, Night, Auto, Schedule
Image Enhancement	BLC, 3D DNR
Wide Dynamic Range (WDR)	120 dB
<b>Interface</b>	
Ethernet Interface	1 RJ45 10 M/100 M self-adaptive Ethernet port
On-Board Storage	Built-in memory card slot, support microSD/microSDHC/microSDXC card, up to 256 GB
Built-in Microphone	-U: Yes
Audio	1 input (line in), two-core terminal block, max. input amplitude: 3.3 Vpp, input impedance: 4.7 K $\Omega$ , interface type: non-equilibrium, 1 output (line out), two-core terminal block, max. output amplitude: 3.3 Vpp, output impedance: 100 $\Omega$ , interface type: non-equilibrium
Alarm	1 input, 1 output (max. 12 VDC, 30 mA)
Reset Key	Yes
Power Output	12 VDC, max. 100 mA
<b>Event</b>	
Basic Event	Motion detection, video tampering alarm, exception
Smart Event	Line crossing detection, intrusion detection
Linkage	Upload to FTP/NAS/memory card, notify surveillance center, send email, trigger recording, trigger capture, trigger alarm output
<b>General</b>	
Power	12 VDC $\pm$ 25%, 0.5 A, max. 6 W, $\varnothing$ 5.5 mm coaxial power plug, reverse polarity protection, PoE: IEEE 802.3af, Class 3, max. 7.5 W
Material	ADC12
Dimension	$\varnothing$ 119.9 mm $\times$ 41.2 mm ( $\varnothing$ 4.7" $\times$ 1.6")
Package Dimension	150 mm $\times$ 125 mm $\times$ 99 mm (5.9" $\times$ 4.9" $\times$ 3.9")
Weight	Approx. 320 g (0.7 lb.)
With Package Weight	Approx. 500 g (1.1 lb.)
Language	13 languages English, Turkish, Polish, Romanian, Czech, Slovak, Traditional Chinese, Thai, Vietnamese, Croatian, Slovenian, Serbian, Ukrainian
Storage Conditions	-10 $^{\circ}$ C to 50 $^{\circ}$ C (-14 $^{\circ}$ F to 122 $^{\circ}$ F). Humidity 95% or less (non-condensing)

Startup and Operating Conditions	-10 °C to 50 °C (-14 °F to 122 °F). Humidity 95% or less (non-condensing)
General Function	Heartbeat, anti-banding, mirror, password protection
<b>Approval</b>	
EMC	CE-EMC: EN 55032: 2015, EN 61000-3-2:2019, EN 61000-3-3: 2013+A1:2019, EN 50130-4: 2011 +A1: 2014 RCM: AS/NZS CISPR 32: 2015 IC: ICES-003: Issue 7 KC: KN32: 2015, KN35: 2015
Safety	UL: UL 62368-1 CB: IEC 62368-1: 2014+A11 CE-LVD: EN 62368-1: 2014/A11: 2017 BIS: IS 13252 (Part 1): 2010/IEC 60950-1: 2005 LOA: IEC/EN 60950-1
Environment	CE-RoHS: 2011/65/EU

## ▪ Typical Application

Hikvision products are classified into three levels according to their anti-corrosion performance. Refer to the following description to choose for your using environment.

This model has NO SPECIFIC PROTECTION.

Level	Description
Top-level protection	Hikvision products at this level are equipped for use in areas where professional anti-corrosion protection is a must. Typical application scenarios include coastlines, docks, chemical plants, and more.
Moderate protection	Hikvision products at this level are equipped for use in areas with moderate anti-corrosion demands. Typical application scenarios include coastal areas about 2 kilometers (1.24 miles) away from coastlines, as well as areas affected by acid rain.
No specific protection	Hikvision products at this level are equipped for use in areas where no specific anti-corrosion protection is needed.



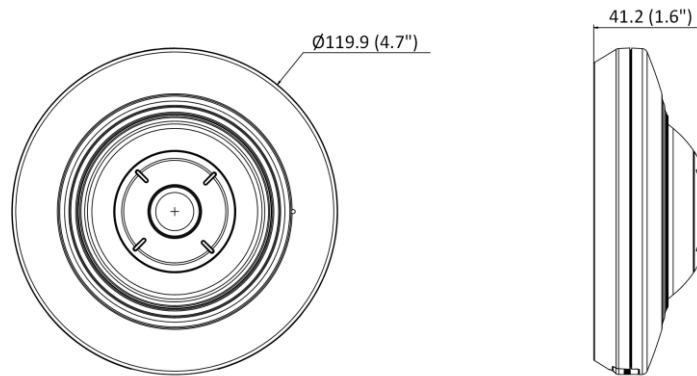



▪ **Dimension**



Unit: mm (inch)

▪ **Accessory**

▪ **Optional**

DS-1297ZJ-M Pendant Mount	DS-1297ZJ-ES Pendant Mount	DS-1294ZJ Wal Mount	DS-1299ZJ Pendant Mount	DS-1281ZJ-DM27 Inclined Ceiling Junction Box
				
DS-1297ZJ Pendant Mount				
				

**ORDERING INFORMATION**

114-729

Hikvision DS-2CD2955G0-ISU 6MP 360 Panoramic 1.05mm



Innovative Electronic Solutions  
www.ness.com.au



**NSW** Ph 02 8825 9222  
sales@ness.com.au

**VIC** Ph 03 9875 6400  
nessmelb@ness.com.au

**QLD** Ph 07 3399 4910  
nessbris@ness.com.au

**WA** Ph 08 9328 2511  
nessper@ness.com.au

**SA** Ph 08 8152 0000  
adelaide@ness.com.au