



D Plus

DPlus Multi-Zone Alarm Platform



DPlus Base Panel
8 Zones



Plus

Keypad options



Plus

Zone Expansion options
up to 32 zones



Plus

4G option



Plus

Ethernet & app option

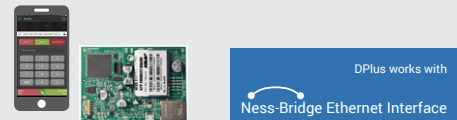

Plus

Wireless options



Plus

Access Control options



8, 16, 24, 32
Hardwired or
Wireless zones

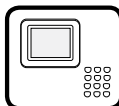

Various
Keypad
Options



4G Cellular
option



Operation by
Smartphone
Internet option



Operation and
Monitoring by
SMS option



Central Station
Monitoring
via IP option



Access
Control
onboard



Powerful
Wireless
Options



Auto-Time
Automation



Multiple
output options

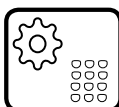

Easy
Programming
via Keypad



Fast
Programming
via PC



Free
NessComms
Installer Software



Convenient
Programming
via SMS



Adjustable
Vibration Inputs
on all Zones



Multiple
Arming
Modes

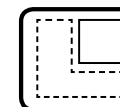

Area
Partitioning



Dual Voltage
17VAC & 20VDC



CORPORATION

Innovative Electronic Solutions

www.ness.com.au

National Customer Service Centre
Ph: 1300 551 991
techsupport@ness.com.au



DPLUS INSTALLATION & PROGRAMMING MANUAL
Document Part No: 890-511 Rev 1.14 April 2026
For use with Ness DPlus control panels V12.0 and later

Related manuals:

890-511-LCD DPlus LCD Keypad User Manual
890-511-NAV DPlus Navigator Keypad User Manual
890-511-COM DPlus Comms Manual

WARNINGS & NOTICES

Ness Corporation manufacturing processes are accredited to ISO9001 quality standards and all possible care and diligence has been applied during manufacture to ensure the reliable operation of this product. However there are various external factors that may impede or restrict the operation of this product in accordance with the product's specification.

These factors include, but are not limited to:

1. Erratic or reduced radio range (if radio accessories are installed). Ness radio products are sophisticated low power devices, however the presence of in-band radio signals, high power transmissions or interference caused by electrical appliances such as Mains Inverters, Wireless Routers, Cordless Phones, Computers, TVs and other electronic devices may reduce radio range performance. While such occurrences are unusual, they are possible. In this case it may be necessary to either increase the physical separation between the Ness receiver and other devices or if possible change the radio frequency or channel of the other devices.
2. Unauthorised tampering, physical damage, electrical interruptions such as mains failure, electrical spikes or lightning.
3. Solar power inverters are a known source of electrical interference. Please ensure that this product and all associated cabling is installed at least 3 metres away from a solar power inverter and its cabling.
4. While SMS reporting is a powerful and useful feature it is dependent on the integrity and availability of the cellular network. As with any SMS message it is possible that SMS monitoring reports may be delayed or fail to be delivered. Such failures are a function of the cellular network/s and beyond the control of Ness Corporation. Ness recommends central station monitoring using an IP protocol as your primary monitoring path.*

* Requires the optional 106-985 4G Comms module which provides central station monitoring via ArmorIP and CSV IP protocols or self-monitoring via SMS messaging.

WARNING: Installation and maintenance to be performed only by qualified service personnel.

CAUTION: Risk of explosion if battery is replaced by an incorrect type. Dispose of used batteries in accordance with local regulations.

All rights reserved. No part of this publication may be reproduced, transmitted or stored in a retrieval system in any form or by any means, electronic, mechanical, photocopying, recording, or otherwise, without the prior written permission of Ness.

Ness reserves the right to make changes to features and specifications at any time without prior notification in the interest of ongoing product development and improvement.

© 2025 Ness Corporation Pty Ltd ABN 28 069 984 372

CONTENTS

Product Features.....	4	AUX OUTPUTS	
Optional products and software	5	Aux1~4 output options.....	49-55
Installation procedures	6	Aux5-8 output options.....	56-58
Inputs and outputs.....	7		
SETUP		Alarm/Fire/Chirp Siren Volume	58
Terminal Blocks.....	8	Enable/Disable hardwire zones	58
Expansion Options.....	8	End Of Line Resistor options.....	59
Installing Optional Modules	9	AUTOTIME OPTIONS	
Connection diagrams	10-11	AutoTime description and examples	60
OPERATION		RealTime Clock programming.....	61
Keypad Displays	12	AutoTime programming.....	62
Keypad Operation - KPX-Plus, Saturn-Plus	13	RADIO OPTIONS	
Keypad Operation - Navigator	14	Ness Radio Interface, connection.....	63
Operation Summary - Keypads, Radio Keys.....	15	Signal Strength Test.....	63
PROGRAMMING		RADIO DEVICE / RADIO KEY Programming	64-65
How to enter Program Mode	16	Serial Interface options	66
Special Functions in Program Mode	16	ACCESS CONTROL OPTIONS	
Quick start Programming.....	17	Weigand Reader wiring diagram	67
PROGRAMMING OPTIONS		Programming access cards.....	68
User Codes	18-19	Access Control options.....	69-72
Remote Panel Options	20	PROGRAMMING OPTIONS SUMMARY	73-78
Timers.....	21	The programming options summary includes all program options for panel and comms.	
Vibration Sensitivity.....	22	Also refer to the separate COMMS Manual for detail.	
Zone Assignment.....	23-24	Specifications.....	79
Definitions. Day Zones, Temp Day Zones, Home	25	Release Notes.....	80
Zones to Mode mapping (Home, 24HR, Day).....	26	Reference.....	81
Zones To Output Mapping	27-28	Installation Record	83
Various Options (Keyswitch input & various)	29-30		
Tamper/Keypad Panic Output Mapping	31		
System Operation Shortcuts.....	32		
Home Mode, Day Mode output mapping.....	33		
Miscellaneous Options	33-34		
Zone Supervision options.....	35-37		
Misc. options	38-41		
FACTORY DEFAULTS			
Clear Radio Devices.....	42		
Clear Memory.....	42		
Clear Panel Options.....	42		
Clear User Codes.....	42		
Program the Installer Code.....	42		
Output Expander options.....	43-45		
Misc. options.....	46-47		

What's New in DPlus

- 8 hardwired (HW) zones expandable to 32 HW zones.
- Supports up to 32 wireless (WZ) zones with a Ness Radio Interface for fully integrated wireless security. Both NESS One Way Radio and TWR receivers can be used together.
- 4G communication option with IP Monitoring (ArmorIP & CSV-IP) and SMS reporting.
- Plug in terminal blocks on main board and all zone expansion boards.
- Supports up to 3 mixed keypads (Navigator/KPX/Saturn) or 4 Navigator keypads.*
- 56 User codes can be programmed to operate by keypad pin, radio key or access card.
- Keypad pin can be used remotely via SMS or Ness-Bridge and app.
- Programmable TWO AREA PARTITIONING can split the panel into two independent areas plus a common area.
- REAL TIME CLOCK with AUTOTIME features - auto arm/disarm, auto aux outputs, time based user control.
- 3 Door ACCESS CONTROLLER onboard with support for weigand prox or fingerprint readers.
- Supports control over the INTERNET using optional Ness-Bridge ethernet interface and free Mezzo app.
- Home mode allows partial arming, (e.g. perimeter security overnight).
- Day mode feature allows daytime monitoring of fire doors, coolrooms etc. Temporary day zone feature allows easy enabling/disabling of day mode.
- Keypad panic and duress feature.
- Two button arming feature.
- Fire alarm feature with different siren tones. Highly flexible zone to output mapping.
- ONBOARD VIBRATION SENSOR ANALYSER with programmable sensitivity. Use with NESSENSOR™ vibration sensors.
- MULTIPLE PROGRAMMABLE EOL resistor values from 0k to 22k (2k2 resistors supplied).
- Siren chirp and strobe flash on arming with radio key. Quiet chirps option on arm/disarm by radio key.
- True DYNAMIC BATTERY TEST actively tests the battery under load every hour and every time a keypad code is entered.
- 8 PROGRAMMABLE AUXILIARY outputs.
- Up to 3 Optional output expanders.
- ENHANCED SERIAL DATA input/output via RS232.
- AUTOMATIC RESET FUSES.
- Programmable Reset Output lockout.
- 30 Event memory from KPX and SATURN keypads. 80 Event memory can be accessed using NAVIGATOR keypad or NESSCOMMS™.
- Standard defaults to suit most applications.
- Easy programming by keypad or optionally by NESSCOMMS™ software via direct connect. All programming data is permanently stored in non-volatile memory.
- All inputs and outputs are heavily protected against lightning and high voltage supply transients.
- High efficiency dc power supply with dual 17vac/20vdc power input

*DPlus requires KPX/Saturn keypads Rev2.0 or later or Navigator touch screen keypad Rev4.0 or later.
4G Comms options require optional 106-985 4G Module



Optional Module

DPlus works with
Ness-Bridge Ethernet Interface

Part No. 106-014

Ness-Bridge Ethernet Interface Module

Ness-Bridge ethernet interface provides internet connectivity for Ness D8/D16 control panels.

Ness-Bridge is an easy installation in Ness Dplus and D8/D16 housings.

Includes red slider mounting rails & 4-wire loom.

Use with Ness Mezzo app.

Further information: [Ness Bridge web page](#)



Ness MEZZO

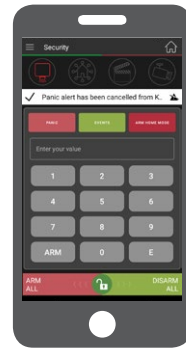

FREE APP

Ness Mezzo App Free app for iOS & Android

Ness-Bridge in combination with the free Ness Mezzo app provides handy remote operation features for your Ness control panels.

- Arm and Disarm
- Home Mode operation
- Operate DPlus outputs
- Receive Push Notifications for Arm/Disarm/Alarm events
- View zones and panel status



Optional Modules



106-982 L16 Local Expander
zones 9-16



106-983 L24 Local Expander
zones 9-24



106-984-x R16 Remote Expander
zones 17-32

Part No. 106-985

DPlus 4G Module

The optional DPlus 4G module provides a 4G pathway for back-to-base monitoring with support for ArmorIP and CSV IP Monitoring protocols, self-monitoring via SMS, operation and programming via SMS.

A Ness SIM card is supplied for your convenience. You can choose to activate the Ness SIM or BYO your own SIM on a network of your choice.

Part No. 106-982 L16 Local Expander, 16 zones

Part No. 106-983 L24 Local Expander, 24 zones

Part No. 106-984-x R16 Remote Expander, 16 zones

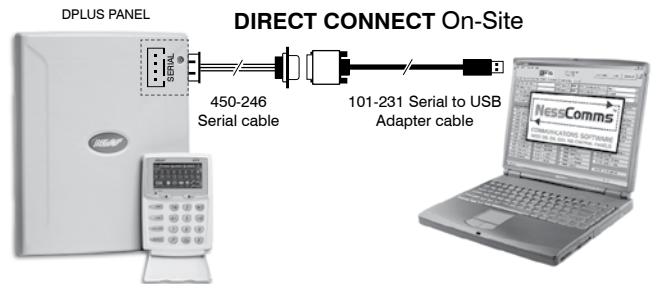

Note:

DPlus and D8/D16XCEL require 450-246 serial cable (4 pin)

Previous versions of D8x/D16x use 450-185 RS232 cable (3 pin)

FREE SOFTWARE

NESSCOMMS

Programming & operation software for PC

- Fast and easy installation programming
- Live zone status mode
- Download system logs, including extended logs not accessible by keypad - up to 80 events
- Database stores hundreds of clients
- Free For Trade users

NessComms makes on-site control panel programming as simple as ticking the boxes.

Direct connect via serial port for fast and easy programming by laptop/PC. The Ness 450-246 Serial Cable and 101-231 Serial-to-USB adapter cables are required.

DPlus requires NessComms V6.00 or later.

ESD WARNING

(Electrostatic Discharge).

Once properly installed, Ness control panels are well protected from ESD. However, take note of the following precautions during installation.

The human body can generate static electricity when it is insulated from earth - for instance by walking over carpet.

ESD occurs (and a small shock is sometimes felt) if an earthed metal object is then touched.

The installer should be aware that if he generates static electricity while installing the panel and then discharges this static electricity into the internal components on the main circuit board or the keypad board, then ESD damage may occur.

The circuit board should not be unwrapped until it is actually ready to be installed.

Methods to avoid electrostatic build-up.

1. Use a foot strap, a wrist strap, or a grounding mat. The aim is to connect the body to earth to discharge static before it builds up. The connection is a high resistance for personnel safety.
2. If the above is not available, then it is advisable to wear clothing that will minimise the build-up of static.
3. Handle circuit boards by the edges. Avoid touching any components on the board as the integrated circuits, in particular, are not guaranteed by their manufacturers to be safe from ESD.
4. To minimise the build-up of static, avoid walking around as much as possible while working on the installation.
5. Touch an earthed object to discharge any static before working on the installation.

INSTALLATION PROCEDURES

The main panel housing and keypad/s should be installed within areas that are protected by motion sensors or reed switches. A linen closet or cupboard are good examples as these are generally located in the centre of the premises. Installing in ceiling spaces or other areas where extremes of temperature may be encountered is not advised.

Positioning of the movement detectors should be considered as the incorrect position may cause unwanted alarms. Refer to the motion sensors' installation instructions.

1. Remove the lid and the battery from the base.
2. Securely mount the rear panel housing in a secure location.
3. Run all cabling needed for the installation.
4. Insert the red PCB stand-offs in the housing and then plug the circuit board onto the stand-offs. See the ESD Warning on this page.
5. Wire the sensors, sirens and accessories to the main board terminal blocks as per the wiring instructions in this installation manual.
6. Connect the 4G antenna connector on the PCB and install the antenna outside the panel housing in a location providing the best signal strength as indicated by the keypad signal strength display.
7. Fit the battery into the housing but **DO NOT CONNECT** the battery yet.
8. Insert the panel tamper bracket leads as shown below.
9. The NESS SIM is factory-fitted or insert your own SIM card as shown.
10. Power up as described below.
11. Close the lid and program the panel as required.

POWER-UP PROCEDURE

To enter INSTALLER PROGRAM MODE the first time, power-up with the PROG/TAMP link OFF. If the PROG/TAMP link is ON and any other 24hr zones are unsealed on power-up the panel will immediately go into alarm - reset the alarm via keypad or remove power to stop the alarm.

1. **CONNECT THE BATTERY FIRST.** Observe correct polarity.
 - a) The RED heartbeat LED will flash continuously to indicate correct operation.
 - b) The Current Limiting Globes should be OFF. If the Globes are glowing, the battery connection is reversed. Immediately disconnect the battery and check the polarity of the battery leads.

If the heartbeat LED does not flash steadily or cycles off intermittently there may be a problem with the initialisation of the onboard memory. **To remedy, in Installer Program Mode press P95E, P97E & P98E to erase all programming and reload factory defaults.** Then remove power by briefly removing one of the battery leads then re-connect. The heartbeat LED should now be flashing continuously, continue the power-up procedure.

2. **TURN ON THE EXTERNAL POWER SUPPLY.** The Current Limiting Globes may glow slightly to indicate that the battery is charging correctly.

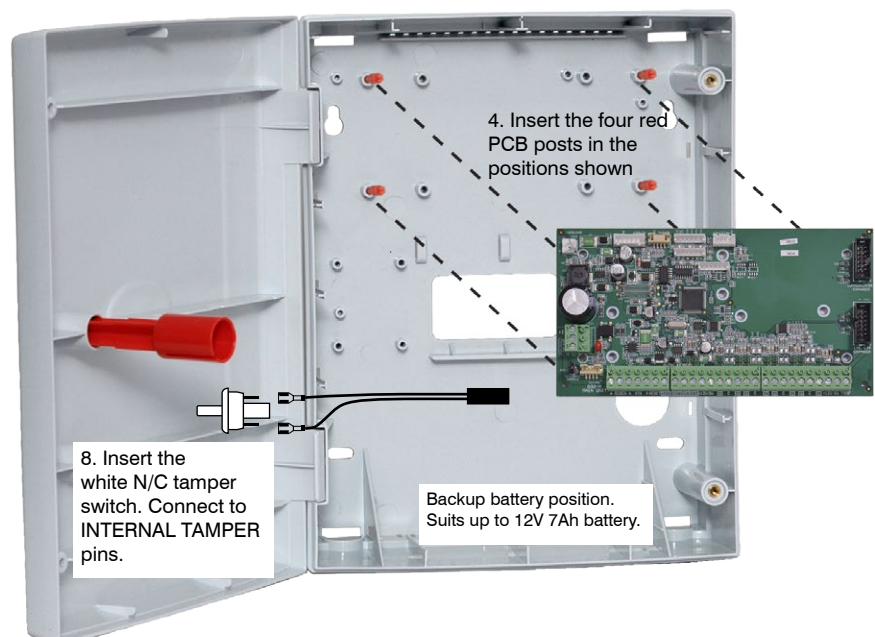

INPUTS

ZONE INPUTS

The Ness DPlus main board has 8 hardwired (HW) zones.

The Ness DPlus main board also supports up to 32 wireless zones (WZ) with the addition of an optional Ness radio interface (One Way Radio or Two Way Radio) regardless of the number of HW zones fitted.

Wireless zones are shared with hardwired zones. For example, in the case of the 8 zone DPlus main board with a radio interface and 32 radio devices, hardwired zones 1-8 would be shared with radio zones 1-8.

Also the DPlus main board has,

1 x 24 hour External TAMP input on the terminal block. EOL input.
1 x 24 hour Box Tamper input on the 2-pin Prog/Tamp input. N/C input. Resistor not required.

END OF LINE RESISTOR

Each zone input must be terminated with an end of line (EOL) resistor unless the zone is disabled by option P125E.

The default EOL resistor value is 2.2k (2200 Ohms) and is fully programmable by program option P129E. Available EOL values being: 0k (closed circuit), 1k, 1K5, 2K2, 3K3, 3K9, 4K7, 5K6, 6K8, 8K2, 10k, 12k and 22k.

TAMP – TAMPER INPUT

The TAMP input must also be sealed with an EOL resistor. This input is always a 24hr input. The EOL value programmed by option p129E also applies to the TAMP input.

POWER INPUT TERMINALS

These terminals are for the connection of the external power supply. Your panel has a dual 17VAC/20VDC power input. Please use the correct power supply as shown on page 10.

EARTH (Functional Earth, not a safety Earth)

Connect a good earth to this terminal to help protect against damage from lightning strikes and static.

BATTERY

These terminals are for the connection of a 12V sealed lead-acid rechargeable backup battery. Charge current is limited to 350mA. The charge voltage is factory preset at 13.8V. Note: The battery must be connected for correct panel operation.

The panel will shut down if battery voltage is below 11V and mains power is off.

Observe correct polarity when connecting the battery.

(Ness Part Number BAT210 12V 7Ah battery)

SIREN LOAD. A maximum output of 2.0A continuous is available from the SIREN and RESET outputs and 200mA from the STR output.

Recommended maximum power load:

3 x Horn speakers (SIREN output)

2 x Strobe lights (STR output)

2 x 12V Internal Screamers (100-238) (RESET output)

Note: (This assumes no more than 500mA is being drawn from the 12V device outputs).

OUTPUTS

12 VOLT OUTPUT

A regulated 13.8 VDC output is available to power detectors and other equipment. This output is available from two sets of terminals marked +12V and 0V. This output is protected by an Automatic Reset fuse.

A maximum load of 500mA may be connected to these terminals.

SIREN

The on-board siren driver will drive a maximum of 3 x 8 ohm horn speakers (Ness Part No. NOI110 or 100-171 Internal Siren). The output will reset at the end of siren time (P29E) or whenever the panel is reset, whichever comes first.

This output is protected by an Automatic Reset fuse.

STR

A latched 12VDC output for connecting strobe lights.

This output will reset after 72 hours (3 days).

A maximum of 2 x 1 Watt Strobes (Ness Part No. NOI300) can be connected to this output.

This output is protected by an Automatic Reset fuse.

RESET

A 12V DC output for connecting Ness sirens, piezo sirens or relays, etc. This output will reset at the end of siren time (P29E) or whenever the panel is reset, whichever comes first.

A maximum of 3 x 12V piezo screamers (Ness Part No. 100-238, 100-004) or 2 X Ness Piezo (Part No 100-172) can be connected to this output.

This output is protected by an Automatic Reset fuse.

AUX HEADERS (AUX1~4, AUX5~8)

The Aux1 to Aux8 outputs are open collector outputs (switch negative) which can supply a maximum of 100mA. Each Aux output can be programmed to perform several different functions. The headers also provides a 12V DC output, max. draw 100mA.

J3 AUX1~4 Header: Connect a 106-103 Four Relay Board or 106-011 Output Expander.

J3A AUX5~8 Header: Connect a 106-103 Four Relay Board. (Do not connect 106-011 Output Expander to this header).

SERIAL PORT (4 PIN)

Two way RS232 serial port for interfacing to NESS-BRIDGE ETHERNET INTERFACE.

Also used for developers to interface to PC or external automation products. The serial data is 9600 baud, 8 data bits, no parity, 1 stop bit. Developer's kit available on request.

PROG/TAMP – PROGRAM LINK & INTERNAL TAMPER INPUT

The PROG/TAMP link appears on the two pin J1 header.

The PROG/TAMP link has two purposes:

1. **To enter Installer Program Mode on initial power up.** Power-up with the PROG link OFF. The PROG link (or Box Tamper lead) must be ON in operating mode.

2. **Box Tamper.** When used with the Internal Tamper Lead (supplied), PROG/TAMP serves as the 24hr tamper input for the panel's internal tamper switch.

Replace the PROG Link with the Box Tamper Lead. Connect the Internal Tamper Lead spade terminals directly to the terminals of the internal tamper switch (supplied). An end-of-line resistor is NOT required on this input.

When PROG/TAMP is used for Internal Tamper, powering up with the panel's cover open will enter Installer Program Mode.

OUTPUT FUSING. The 12V outputs, Siren, Reset and Strobe outputs are protected by Automatic Reset electronic fuses. These outputs will automatically reset once the overload is removed.

TERMINAL BLOCKS - LAYOUT

DPlus boards are supplied with high quality removable rising clamp style terminal blocks.

The terminal blocks provided are either 3-way, 4-way, 7-way or 10-way and should be fitted in combinations as shown below.

Note, if your product was supplied with only 3-way and 4-way blocks these can be joined together to form the required 7-way and 10-way blocks.

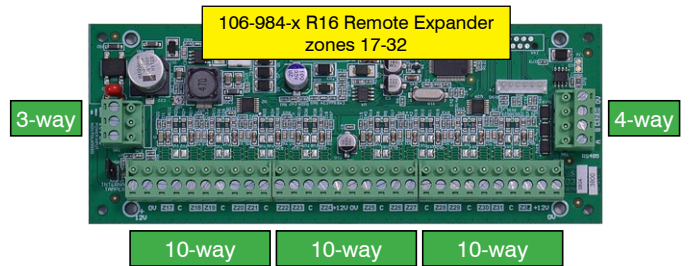
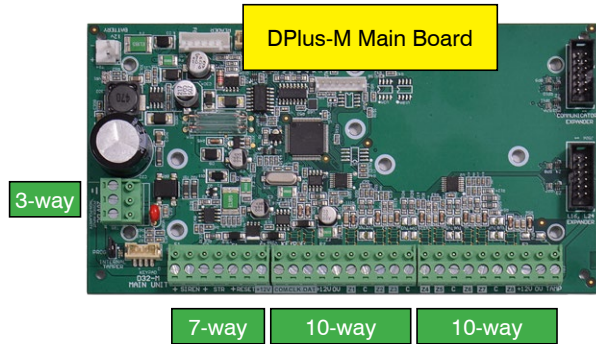
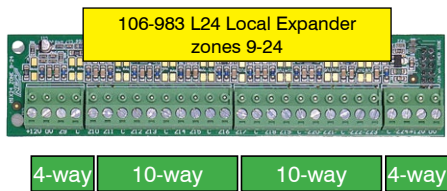
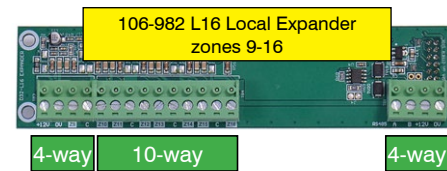

EXPANSION OPTIONS, Hardwired (HW) & Wireless (WZ)

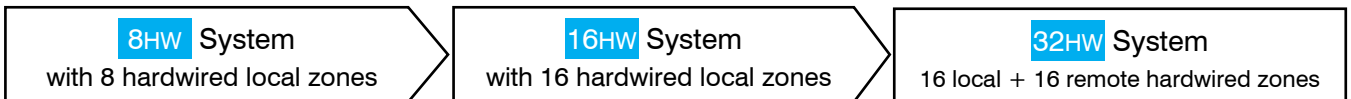

Up to **32WZ** wireless zones*

Up to **32WZ** wireless zones*

Up to **32WZ** wireless zones*

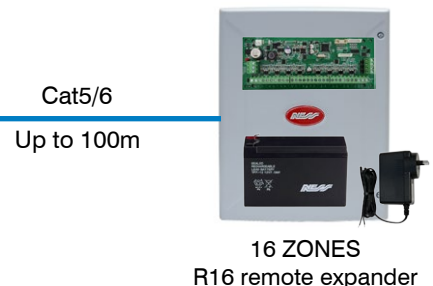
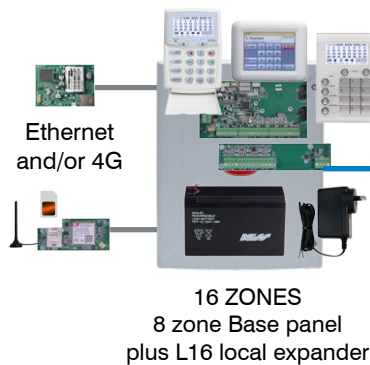
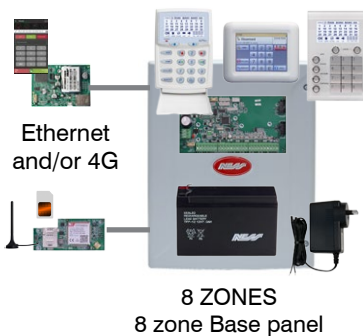

Up to **32WZ** wireless zones*

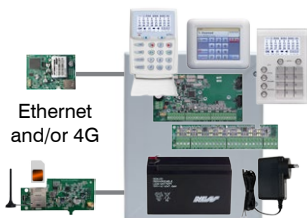

24 ZONES
8 zone Base panel
plus L24 local expander.
Not further expandable.

* DPlus supports up to **32** wireless zones (WZ) in any combination with hardwired zones.

Example1: One device per zone:
The 8 Zone Base panel with a wireless interface supports 8 hardwired zones plus 24 wireless zones = 32 total.

Example2: Each zone hosting a hardwired and a wireless device:
This allows expansion to 32 hardwired zones and 32 wireless zones = 64 total.

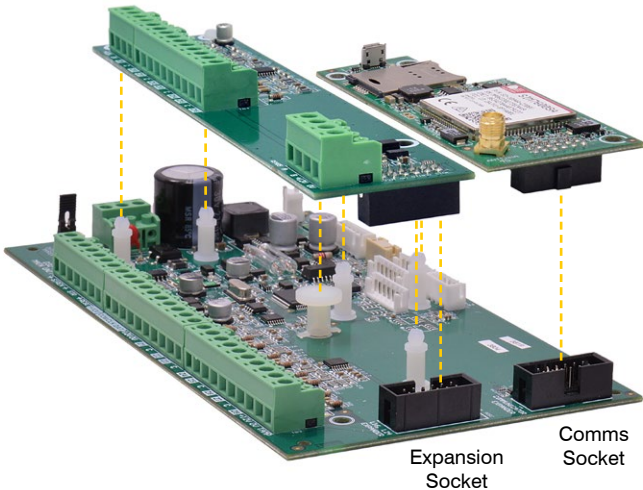

INSTALLING MODULES

DPlus main board accommodates one optional plug-in expander module and one communicator module.

The main board must be powered down when connecting or disconnecting plug-in modules.

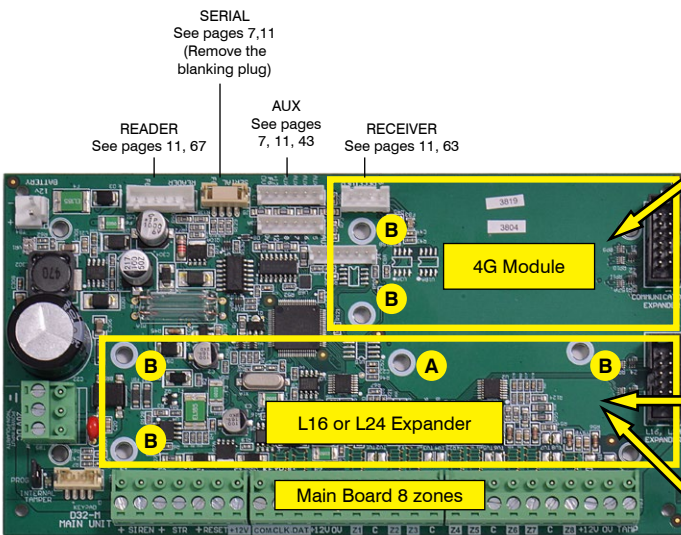

4G COMMUNICATOR MODULE



For programming details refer to the separate DPLUS COMMS MANUAL.

LOCAL ZONE EXPANSION

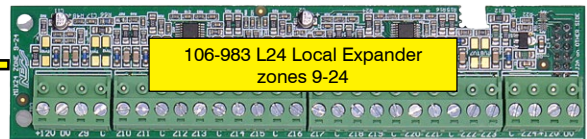

The main board with the L24 expander board fitted provides 24 hardwired zones. Not further expandable.



The main board with the L16 expander board fitted provides 16 hardwired zones. Further expandable to 32 zones using the R16 expander.

The white rimmed holes marked A & B on the main board are provided for expander board supports.

First install the supports on the main board then fit the expander/s. The supports keep the expander boards in place and lock them into the connecting socket.

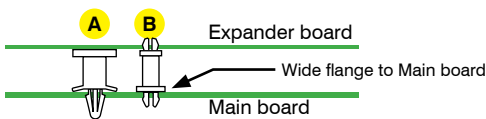

Flat Top Support
L16 Expander, 1pc
L24 Expander, 1pc

11mm Support
L16 Expander, 3pcs
L24 Expander, 3pcs
4G Module, 2pcs

R16 Remote Expander should be powered by 20VDC plug pack and backup battery at the remote location. (Recommended)

Alternatively it can be powered solely by the 4-wire bus provided that the total power budget for the main board and expander is not exceeded. (P01E 13E & 14E must be OFF to prevent mains fail and low battery alarms from the remote board.)

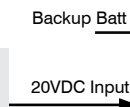

REMOTE ZONE EXPANSION

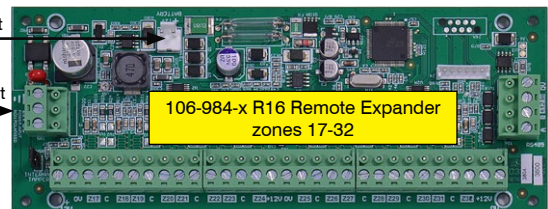

R16 remote expander provides an additional 16 hardwired zones up to 100m distance from the main board. Connection is via a 4-wire bus to the L16 expander fitted on the main board.

R16 remote Expander Part Numbers

106-984-P	DPlus-R16 16 Zone remote expander kit in plastic box	Inc Plug pack & Batt inc plastic box
106-984-M14	DPlus-R16 Remote Expander with 14" Kit	Inc Plug pack & 12V 7Ah batt
106-984-M28	DPlus-R16 Remote Expander with 28" Kit	Inc Plug pack & 12V 7Ah batt
106-984-M	DPlus-R16 Remote Expander with stand-offs	inc supports for installation in existing 14" or 28"

Cat5/6
Up to 100m

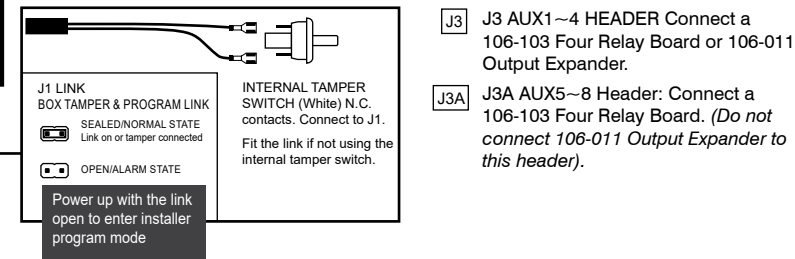
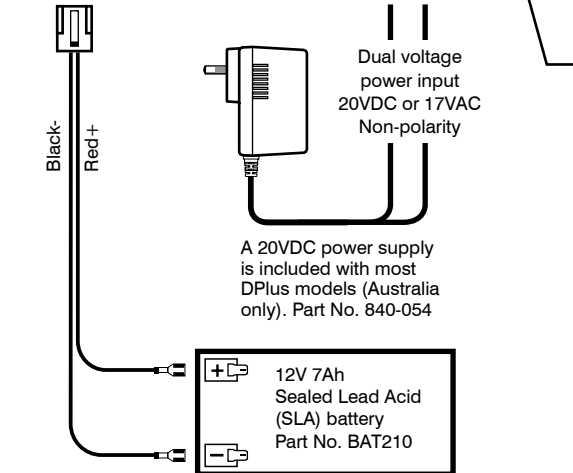
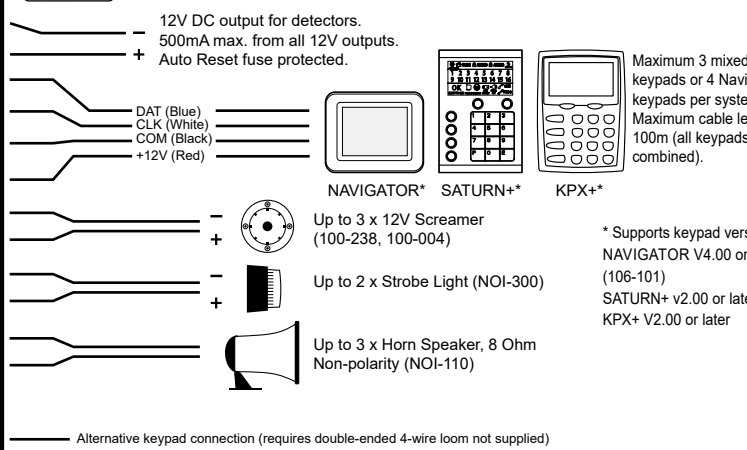
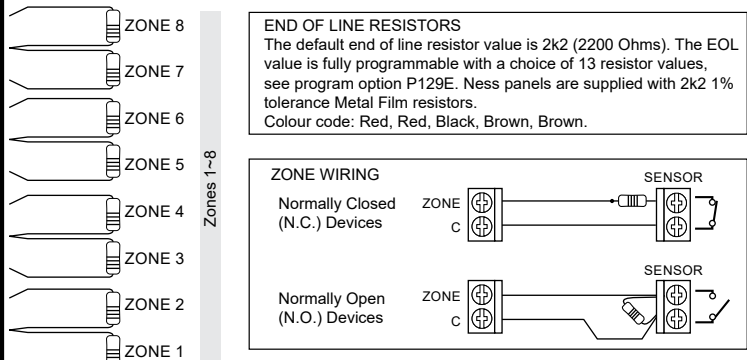
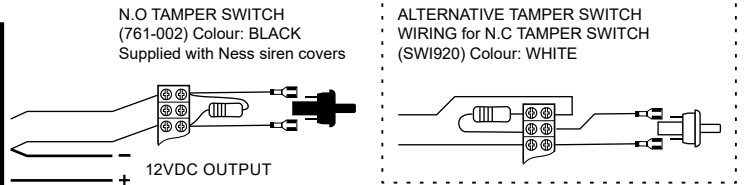
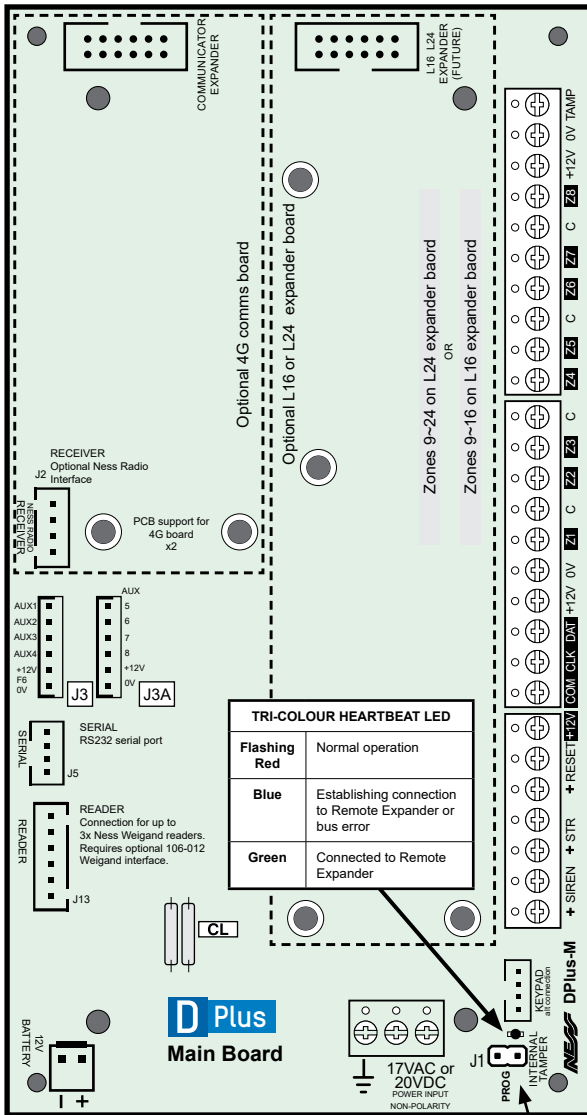

CL CURRENT LIMITING GLOBES	
Not glowing	Normal - battery is charged
Slight glow	When charging a new battery
Intensely bright	The battery is drawing excessive current and may be faulty, or the battery is connected in reverse. Check the connections or connect a charged battery.

Siren Wiring Example

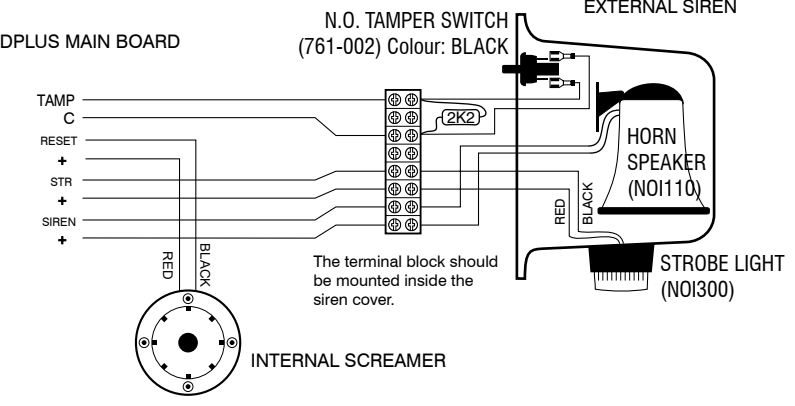

Optional Accessories for DPlus

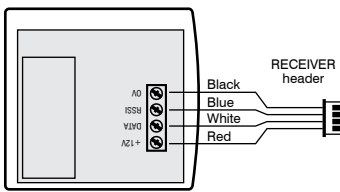

100-200 Ness Radio Interface
One Way radio interface.

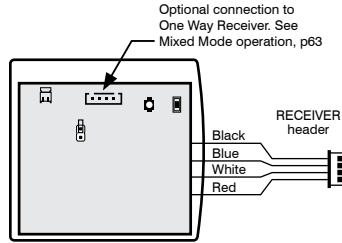

106-462 Ness X-TWR
Two Way radio interface.

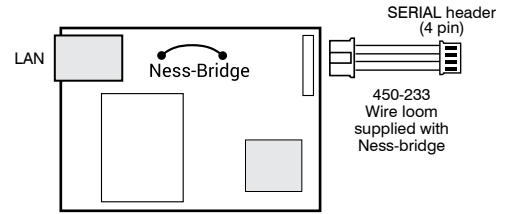

106-014 Ness-Bridge Ethernet Interface
for use with Ness Mezzo app.

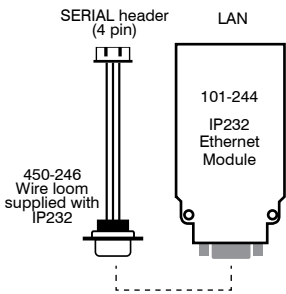

101-244 Ethernet interface.
Provides internet connectivity for use with third party apps such as iComms & aComms.

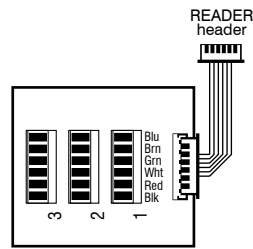

106-012 Weigand Interface.
Provides connection for up to 3 addressable Weigand Readers (Ness 101-014). See Access Control options, pages 67-72.

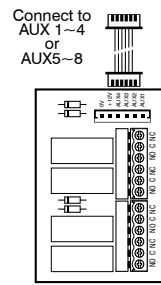

106-013 Relay Board.
Provides 4 relay outputs suitable for switching low voltage accessories.

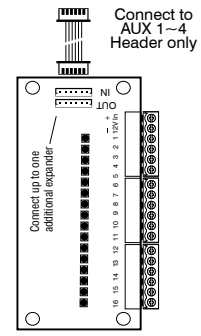

106-011 Output Expander/s
Provides programmable open collector outputs. See pages 43-45.

Both expander boards can co-exist. Example, connect Output Expander to AUX1-4 and Relay Board to AUX5-8

Generic Detector Wiring Examples

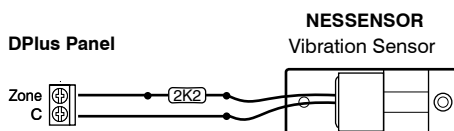
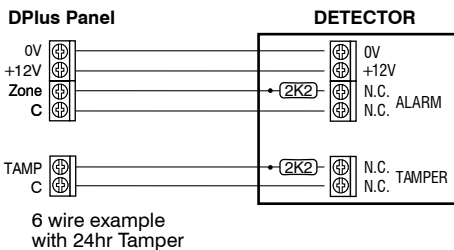
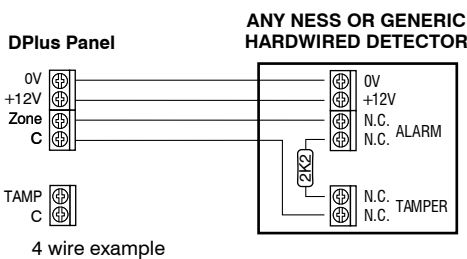

See P30E--P36E Zone Vibration Sensitivity, page 22

LUX HW Detector Wiring

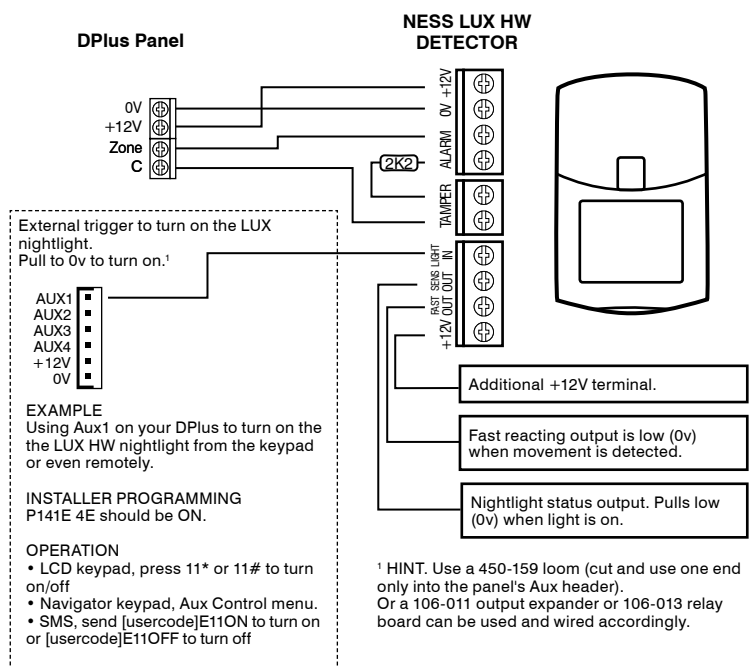

KEYPAD DISPLAY IN OPERATING MODE

DISPLAY	OFF	ON	FLASHING
ZONES 1-32	Zone is sealed.	Zone is unsealed.	Zone is in alarm.
OK TO ARM	Zone/s are unsealed OR Power fault OR Panel is armed	Ready to Arm	
ARMED	Panel is disarmed, or Area 1 is disarmed, if using Areas.	Panel is armed, or Area 1 is armed, if using Areas.	
ARMED	Area 2 is disarmed.	Area 2 is armed if using Areas.	
HOME	Home Mode is disarmed.	Panel is armed in Home Mode.	Day Mode enabled, (see page 26).
MEM	Normal.	Memory mode selected.	New alarm/s in memory.
	Normal.	Receiving a radio signal. (If radio fitted.)	A Radio Key or other radio device has low battery.
 TAMPER	Normal.		Internal Tamper: Double Flash with long pause. External Tamper: Steady flash.
 EXCLUDE	Normal.		Zone/s are Excluded.
 LOW	Normal.		The backup battery is low.
 OFF	Normal.		Mains power is off.
CELL	<p>Cellular signal strength status - alternates with real time clock display. Signal strength range is 00 (no signal) to 30 (Best signal). Signal strength below 5 means the antenna should be checked or moved to a better reception area.</p> <p>The CELL icon indicates various cellular conditions.</p> <ol style="list-style-type: none"> CELL with flashing signal strength indicates the communicator is in use. indicates a cellular communicator fault. CELL with flashing indicates 'no SIM' Card is fitted. 		
TIME	Real time clock display - alternates with cellular signal strength status.*		
PROG	Normal.	User Program Mode.	Installer Program Mode.

KEYPAD BEEPS

BEEPS	MEANING
1 BEEP	Any key press.
3 BEEPS	Valid Command.
1 LONG BEEP	Error.
10 BEEPS	Mains Power is off or Panel Battery is low or A Radio Device has sent a low battery signal or Comms Fail has been detected.
Constant SLOW beeps	An AutoTime action is due to begin.
Constant FAST beeps	An AutoTime action will begin in one minute.

KEYPAD DISPLAY IN MEMORY MODE

KEYPAD ICON	MEMORY EVENT
Zone numbers 1-32	Zone alarm
(no icons displayed)	Panel Disarmed
ARMED	Panel Armed (or Area 1 Armed)
ARM2	Area 2 Armed
MAINS	Mains power failure
BATTERY	Low Battery
TAMPER + 1	Internal Tamper alarm
TAMPER + 2	External Tamper alarm
EXCLUDE + 1	Panic alarm
EXCLUDE + 2	Medical alarm
EXCLUDE + 3	Fire alarm
RADIO, EXCLUDE	Radio Key Panic alarm
RADIO, BATTERY, ZONE	Radio Device battery low, (Device number is indicated by zone lights)
RADIO, BATTERY, ARM	Radio Key battery low, (Radio Key number is NOT indicated)
RADIO, TAMPER, ZONE	Radio Device tamper alarm (Device number is indicated by zone lights)
RADIO, HOME, ZONE	Radio Supervision alarm (Device number is indicated by zone lights)
HOME, ZONE	Wired Zone Supervision alarm (Zone number is indicated by zone lights)

* The onboard clock is automatically updated from your cellular network if the optional 106-985 Comms Module is fitted. Otherwise set the current time using program options P340E-P344E.

KPX+ LCD KEYPAD



DPlus requires KPX+ V2.00 or later

Panic Alarm
Press and hold the two emergency keys together for PANIC alarm.
See P126E 1E to enable. See P75E 3E, P191E 3E to enable panic alarm reporting

Fire Alarm
Press and hold the two FIRE (1 & 3) keys together for FIRE alarm.
See P126E 2E to enable the keys. See P75E 4E to enable fire alarm reporting.

Medical Alarm
Press the two Medical (4 & 6) keys together for Medical alarm.
See P126E 3E to enable the keys. See P75E 2E to enable medical alarm reporting.

The **CELL** icon indicates various cellular conditions.*

1. **CELL** with flashing signal strength  indicates the communicator is in use.
2.  with flashing **CELL** indicates a cellular comms fault.
3. **CELL** with flashing  indicates 'no SIM' Card is fitted.

Adjust LCD Backlight

Press and hold the **9** key to adjust the brightness of the LCD and keys backlighting. Release when the desired brightness is reached.



Note. Beep/Chime Volume and LCD Brightness settings are stored in the keypad. Adjust each keypad individually. Defaults to loudest/highest settings on power down.

Adjust Key Beep Volume

Press and hold the **P** key. Release when the desired volume is reached.

The volume level is displayed on the LCD during adjustment.

Adjust Chime Volume

Press and hold the **0** key. Release when the desired volume is reached.

The volume level is displayed on the LCD during adjustment.

Display Test



To display all available LCD icons press and hold the **E** key.

Display Test can be used in any mode.

SATURN+ LCD KEYPAD

DPlus requires Saturn+ V2.00 or later

All the key functions described above also apply to Saturn keypads.



Keypad Tamper Alarm

Applies to all keypads and is designed to prevent multiple attempts to guess a user code either at the keypad or by SMS.

A Keypad Tamper alarm is generated by 5 failed attempts to arm, disarm or any other command that requires entry of a user code.

Keypad Tamper Alarm sounds the Siren, Strobe and Reset outputs. A Keypad Tamper report is sent by CID or SMS if programmed by P75E, P191E.

Clear the alarm by entering a valid user code + E

* SMS programming and operation requires the optional 106-985 4G Module

NAVIGATOR TOUCH SCREEN KEYPAD

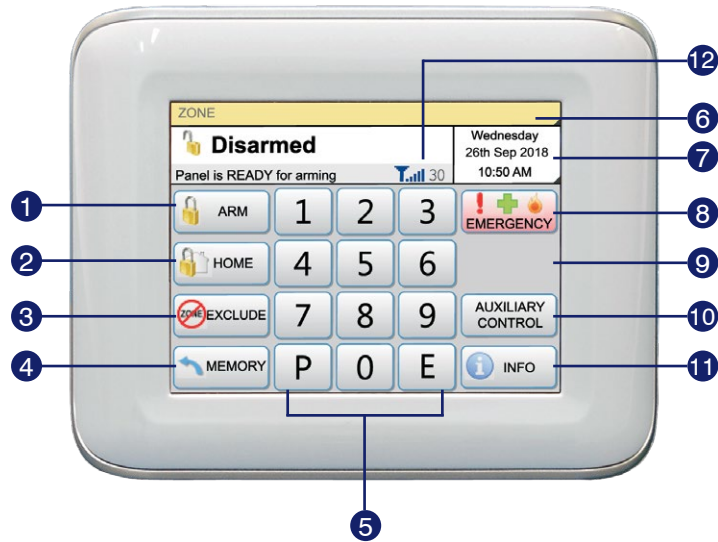

DPlus requires Navigator V4.00 or later. Part No. 106-101

- 1 Touch to arm the system.
- 2 Touch to arm Home Mode.
- 3 Touch to Exclude zones.
- 4 Touch to view the event memory.
- 5 Numeric keypad.
- 6 Touch to view the full zone list.
- 7 Touch here to view the calendar. This area also displays System Alarms.
- 8 Touch to activate the Emergency Alarms.
- 9 This area displays current Emergency Alarms.
- 10 Touch to control the Auxiliary Outputs.
- 11 Touch to display the information screens.
- 12 Cellular signal strength display

ZONE 1 2 3 4 5 6 7 8 9 10 11 12 13 14 15 16

The Zone Status Bar displays the zone numbers of unsealed zones.

ZONE 1 - Front Door

If only one zone is unsealed its description will also be displayed.

ZONE 1 - Front Door

Zones which are currently in the alarmed state are displayed in flashing red text.

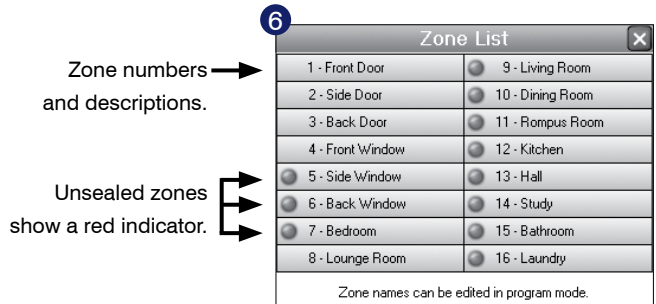

Touch to close the window.



Note: Text Names displayed by the Navigator Keypad can only be programmed by SMS messaging as described in the separate DPlus Comms Manual.

This includes Zone Names, User Names and Installer Details for display on the Navigator keypad and for reporting by SMS messaging.

* SMS programming and operation requires the optional 106-985 4G Module

OPERATION SUMMARY

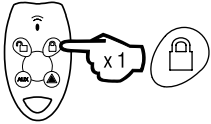
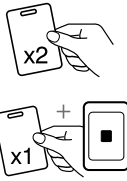
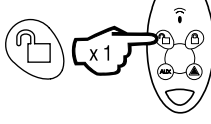
Central Station Reporting and operation by SMS requires the optional 106-985 4G Module

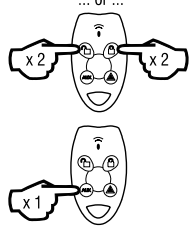
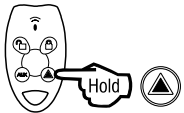
OPERATION	by KEYPADS & SMS (Optional)	by RADIO KEY	by ACCESS CARD or FOB
to ARM The panel must initially be disarmed.	ALL KEYPADS ARM + E If the Arming Shortcut is enabled, P62E 5E or ARM + [UserCode] + E or [UserCode] + E If Code Only Arming has been enabled for that user code. Extra Option 4E SMS A[UserCode]E	 <p>Press the ON button once.</p>	 <p>Present a Card or Fob twice. (if P301E 2E is on). Or, present a Card or Fob once + press button. (if P301E 3E is on).</p>
to DISARM To disarm and/or reset alarms.	ALL KEYPADS [UserCode] + E SMS [UserCode]E	 <p>Press the OFF button once.*</p>	 <p>Present a Card or Fob once. (if P301E 4E is on).</p>
to arm HOME MODE Area1 must initially be disarmed. Home Mode can be used if the panel is fully disarmed or if only Area2 is armed, see page 24-25 for more information.	ALL KEYPADS HOME + E (If the Home Shortcut is enabled, P62E 3E) or HOME + [UserCode] + E SMS H[UserCode]E	 <p>Press either the OFF button or the ON button twice within 4 seconds. (P69E 5E must be on). Or press the AUX button once. (If P120E 3E is on). RK4 radio key only. Radio Key Home Arm chirps can be enabled by P120E 2E. Radio Key Home Arm strobe flash can be enabled by P64E 6E, (off by default).</p>	<p>Press either the OFF button or the ON button twice within 4 seconds. (P69E 5E must be on). Or press the AUX button once. (If P120E 3E is on). RK4 radio key only. Radio Key Home Arm chirps can be enabled by P120E 2E. Radio Key Home Arm strobe flash can be enabled by P64E 6E, (off by default).</p>
PANIC alarm	KPX/SATURN * [Panic] # together or * [Panic] + [UserCode] + E or * [Panic] + E (If Keypad Panic Shortcut is enabled, P62E 4E) NAVIGATOR press EMERGENCY then press PANIC SMS S[UserCode]E	 <p>Press and hold the PANIC button for at least 4 seconds. If P68E 1E Double Press Radio Panic is enabled, press and hold twice for 4 sec.</p>	<p>Press and hold the PANIC button for at least 4 seconds. If P68E 1E Double Press Radio Panic is enabled, press and hold twice for 4 sec.</p>
FIRE alarm MEDICAL alarm	<p>FIRE Alarm KPX/SATURN 1 & 3 together NAVIGATOR press EMERGENCY then press FIRE MEDICAL Alarm KPX/SATURN 4 & 6 together NAVIGATOR press EMERGENCY then press MEDICAL</p> <p>NOTES The FIRE alarm sounds the siren using the FIRE siren sound and sends a fire report if programmed. The MEDICAL alarm triggers the strobe light if programmed and sends a medical report if programmed. Related options for Fire and Medical P75E, P77E, P191E, P193E, P161E, P126E 2E 3E, P69E 1E</p>		
KEYPAD DUESS Keypad Duress allows the user to send a silent duress report while disarming, (if the system is being monitored by a central station).	ALL KEYPADS [5, 6, 8 or 9] + [UserCode] + E Add one these digits in front of a user code when disarming. This sequence will disarm the panel and sends a Duress report to the central station. This is a silent alarm with no indication at the keypad/s. (Report Keypad Duress must be enabled, P75E 1E)		
EXCLUDE ZONES EXCLUDE + E can only be used when the panel is disarmed. EXCLUDE + CODE + E can be used anytime.	ALL KEYPADS EXCLUDE + E (If the Exclude Shortcut is enabled, P62E 2E) then KPX/SATURN [ZoneNumber] + E [ZoneNumber] + E (Enter the zone number/s to be excluded.) NAVIGATOR [SelectZones] then KPX/SATURN press E to exit Exclude mode or NAVIGATOR press X to exit. The Exclude icon flashes constantly while zones are excluded. Excluded zones are automatically included on disarming.		
OPERATE AUX OUTPUTS The AUX outputs must be enabled for operation by keypad. See P141E 4E, P142E 4E, P143E 4E, P144E 4E.	KPX/SATURN [Aux No twice] + * [Panic] to turn ON or PULSE an output. [Aux No twice] + [Panic] # to turn off. NAVIGATOR press AUXILIARY CONTROL press AUX outputs on/off. SMS [UserCode]E[AuxNumber]E Note, via SMS enter the Aux output numbers as double digits. For example to turn on Aux1 send [UserCode]E11E (therefore Aux2 is 22, Aux3 is 33 etc.) See the separate Comms manual for further detail.		

* If a user code is assigned to a radio key and has Extra Option 4E enabled, (Code Only arming), then pressing OFF toggles the arm/disarm state.

* SMS programming and operation requires the optional 106-985 4G Module

PROGRAMMING

FACTORY DEFAULT
 Master Code: 123
 Installer Code: 000000

USER PROGRAM MODE
 User Program Mode allows the owner to program:

- All User Codes
- Entry Exit Times
- SMS Telephone numbers
- Real Time Clock settings

Note: The panel will automatically drop out of User Program Mode to Operating Mode if no keypad buttons are pressed for 4 minutes.

INSTALLER PROGRAM MODE
 Installer Program Mode allows access to ALL program options.

NOTE 1. NessComms Direct Connect via the serial port requires the panel to be in Installer Program Mode.

NOTE 2. The panel will remain in Installer Program Mode until P + E is entered by keypad.

INSTALLER'S HANDY HINT
 All inputs are disabled while the panel is in Installer Program Mode. This handy feature allows you to work on the system without triggering 24 hour zones such as tamper inputs.

HOW TO ENTER PROGRAM MODE

FIRST TIME PROGRAMMING FROM POWER UP

1. Power-up with the J1 PROG/TAMP link OFF.
2. The panel is now in Installer Program Mode. Program the panel as required.
3. Replace the PROG/TAMP link (or Box Tamper lead) **before** you exit program mode. The link must be on in normal operating mode.

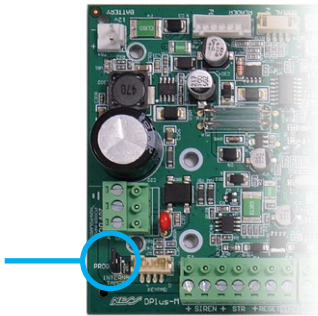

USING A KEYPAD TO ENTER PROGRAM MODE

The panel must be Disarmed.

1. Press P + [MasterCode] + E
 This is User Program Mode (PROG icon is ON). Various user options can be programmed in this mode.
2. Press P + [InstallerCode] + E
 This is Installer Program Mode (PROG icon is FLASHING). All program options can be programmed in this mode.

HOW TO EXIT PROGRAM MODE

Press P + E

Exits directly to Operating Mode (PROG icon is OFF).

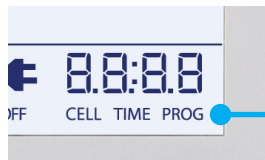

KPX+ and Saturn+ Keypads
 PROG on = User Program Mode
 PROG Flashing = Installer Program Mode

Navigator Keypad displays the mode on screen.

SPECIAL FUNCTIONS IN PROGRAM MODE

SPECIAL FUNCTION	PROGRAM MODE	KEYPRESS
SEND COMMUNICATOR TEST REPORT Send a Test Report to the reporting number programmed at P170E.	USER	P 66666666 E (eight 6's)
SIREN TEST Turn the Siren, Reset and Strobe Outputs On. Pressing P E will stop the Siren Test (and also exits Program Mode).	USER or INSTALLER	P 77777777 E (eight 7's)
PANEL RESET This function resets the microprocessor. The effect is the same as powering down and powering up again. INSTALLER'S TIP: Use P88888888E prior to powering down for a short time. This will save the current Time Before Next Test Call and the Real Time Clock into permanent memory. On power up these times will be restored.	USER or INSTALLER	P 88888888 E (eight 8's)
DISPLAY FIRMWARE VERSION This function displays the panel firmware version when in program mode. Displayed in decimal format by the zone LEDs. Example, version V6.1 is displayed by flashing 6 followed by 1.	USER or INSTALLER	P 99999999 E (eight 9's)

Quick Start Programming Guide via Keypad

Use one of these Quick Start programming summaries for fast setup of your control panel with typical options. These examples show programming by KPX or Saturn keypad, Navigator touch screen keypad follows the same logic.

QUICK START 1 - Local System

Just program a User Code and it's ready to go.

STEP	KPX+ or SATURN KP	DESCRIPTION	COMMENT
1	P 1 2 3 E	Enters User Program Mode.	PROG icon will turn on. (The default Master Code is 123)
2	P 2 0 1 E	Selects the option for User Code 1.	The existing code will be displayed.
3	____ E	Enter your new user code followed by E.	Keypad codes can be 3 to 6 digits in length. The PIN must not start with 0 (zero).
4	____ E	Enter your new user code again.	The new code will be displayed.
5	P E	To exit program mode.	PROG icon will turn off.

QUICK START 2 - Using the Ness-Bridge Ethernet Interface

Program a user code and enable the serial port options.

Requires optional 106-014 Ness-Bridge Ethernet Interface.

STEP	KPX+ or SATURN KP	DESCRIPTION	COMMENT
1	P 1 2 3 E	Enters User Program Mode.	PROG icon will turn on. (The default Master Code is 123)
2	P 0 0 0 0 0 0 E	Enters Installer Program Mode.	PROG icon will flash. (The default Installer Code is 000000)
3	P 2 0 1 E	Selects the option for User Code 1.	The existing code will be displayed.
4	____ E	Enter your new user code followed by E.	Keypad codes can be 3 to 6 digits in length. The PIN must not start with 0 (zero).
5	____ E	Enter your new user code again.	The new code will be displayed.
6	P 1 9 9 E 1E 2E 3E 4E 5E 6E 7E	Selects the option for Serial Outputs. Turn on options 1E ~ 7E to enable operation for Ness-Bridge.	This mobile phone number will receive alarm reports, if enabled. 3 mobile numbers can be programmed to receive alarm reports. 1 mobile number can receive open/close reports, see P180E to P189E. See P190E to P194E to enable/disable various SMS alarm reports.
7	P E	To exit program mode.	PROG icon will turn off.

QUICK START 3 - For Central Station Monitoring

Program a user code, central station ph number & acc number.

Requires optional 106-985 DPlus 4G Module. See the separate DPlus Comms Manual for full details.

STEP	KPX+ or SATURN KP	DESCRIPTION	COMMENT
1	P 1 2 3 E	Enters User Program Mode.	PROG icon will turn on. (The default Master Code is 123)
2	P 0 0 0 0 0 0 E	Enters Installer Program Mode.	PROG icon will flash. (The default Installer Code is 000000)
3	P 2 0 1 E	Selects the option for User Code 1.	The existing code will be displayed.
4	____ E	Enter your new user code followed by E.	Keypad codes can be 3 to 6 digits in length. The PIN must not start with 0 (zero).
5	____ E	Enter your new user code again.	The new code will be displayed.
6	P 1 7 0 E	Selects the option for Reporting No 1.	Enter the IP address provided by your central station. If a URL is provided it must be programmed by SMS. See the Comms Manual, page 12.
7	_____ E	Enter the central station IP Address:Port followed by E	30 digits maximum.
8	P 7 2 E	Selects the option for Account No 1.	
9	____ E	Enter the Account number followed by E	4 digits maximum. The account number is supplied by your central monitoring station.
10	P E	To exit program mode.	PROG icon will turn off.

P401E – P432E

P201E – P256E

PROGRAM MODE LEVEL

User, Installer

FACTORY DEFAULT

User Code 1: 123

All other codes: [blank]

NOTES

1. To clear all codes (except the Installer Code), enter P98E in Installer Program mode. This also defaults user code 1 to 123. See Page 42.

2. Open/Close reports are identified by user number when the control panel is base station monitored.

RELATED OPTIONS

Installer Code. See Page 16, How To Enter Program Mode.

Page 42, Programming the Installer Code. Installer Code Default 000000

RELATED OPTIONS

Programming Radio Codes, page 65

IMPORTANT NOTES

❗ A User Code can be a Keypad Code, Radio Code or Reader Code, but only one type at any one time.

❗ By factory default all user codes are Keypad Codes.

❗ Any user codes not assigned to be Radio Codes or Reader Codes remain as Keypad Codes.

❗ When a user code is selected as a Radio Code or Reader Code, its Keypad Code (if any) is automatically deleted. The same applies to Radio Codes and Reader Codes - their codes are auto deleted when the code is changed to any other type.

❗ User Code 1 is the Master Code and is always a keypad code and cannot be programmed to be a Radio Code or Reader Code.

❗ User Codes must not start with zero. eg, 01234 is not allowed.

PROGRAMMING USER CODES BY SMS*

SMS

User codes can also be programmed using XCEL app or by direct SMS messaging from a phone.

Example: To program user code 2 to be 5678
SMS to the panel:
P123E P202E 5678E 5678E

*Operation by SMS requires the optional 106-985 4G Module

RADIO DEVICE PROGRAMMING SEE PAGE 64

USER CODES, PROGRAMMING BY KEYPAD

See the separate Comms manual for SMS programming instructions.

DPlus has 56 User Code "Slots" which are used to operate the panel by a variety of methods.

Each User Code can be assigned to either a KEYPAD CODE or a RADIO KEY or an ACCESS CARD.

KEYPAD (PIN) CODES

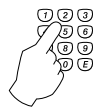

Up to 56 Keypad Codes can be used at up to 3 wired keypads for controlling all panel functions including Arming/Disarming, Home Mode, Panic, memory recall and much more.

- Keypad Codes can be 3 to 6 digits in length and can be individually programmed and deleted.

- Keypad Codes can optionally be programmed to be "Arm Only" codes.
- User Code 1 is also the Master Code which is used to enter Client Program mode.
- All 56 User Codes are Keypad Codes by default. User Codes can be programmed to be Radio Codes or Access Cards as required.
- **USER CODES MUST NOT START WITH ZERO (0). The panel will allow codes with leading zeros but the code will NOT operate the panel.**
- All codes must be unique to each other. Codes are rejected if already used. Some codes that are similar to existing codes may also be rejected.

PROGRAMMING KEYPAD CODES

Press P [Any user option number from 201 to 256] E (The existing code is displayed one digit at a time).

Press [NEW CODE] E [NEW CODE AGAIN] E (The new code is displayed).

Example: To program the Master Code to be 1234.

Press P201E 1234E (1 beep) **1234E** (3 beeps)

❗ When replacing a Keypad Code, the old code does not need to be deleted first. The new code will overwrite the old code.

DELETING KEYPAD CODES

To delete a User Code without programming a new code, press the MEMORY key in place of the code.

Example: To delete User Code 2, press **P202E MEMORY E**

❗ A keypad code only needs to be deleted if you're not replacing it with a new code.

Note that User Code 1 (Master Code) cannot be deleted but can be reprogrammed.

ARM ONLY CODES

'Arm Only' is an extra option for user codes. See next page for further information.

User Codes 2–56 can optionally be programmed as Arm Only Codes, which can Arm but cannot Disarm the panel. (Used for cleaners, temporary staff, etc).

Example: To program User Code 2 to be 1234 and an Arm Only code.

Press P202E EXCLUDE E 3E EXCLUDE E 1234E 1234E

(EXCLUDE E enters Extra Options mode, 3E enables the Arm Only option, then EXCLUDE E toggles back to normal user code program mode.)

When the code is viewed in program mode, the ARMED icon is briefly displayed before the digits of the code.

To disable the Arm Only feature for a keypad code, simply enter the option for that code, press EXCLUDE E to view Extra Options then press 3 E without re-entering a new code. This retains the existing code and toggles off the Arm Only feature.

❗ The Arm Only feature also applies to Radio Keys and Access Cards.

❗ Arm Only codes can also arm the panel directly from Home Mode. (Normally, user codes can arm the panel only if it is fully disarmed).

❗ Arm Only codes can also arm Home Mode as normal.

❗ Radio Keys programmed as an Arm Only can toggle the armed/disarmed state of the panel using the OFF button on the radio key.

**USER CODE
OPTIONS TABLE**

KPX+ EXCLUDE+E toggles Extra Options mode.
NAVIGATOR Press Extra Code Options.
 (Installer Program mode only)

USER CODE	OPTION NO.	KEYPAD PIN	1E AREA 1 CODE	2E AREA 2 CODE	3E ARM ONLY	4E "CODE ONLY" ARM (REX CODE)	5E RADIO CODE	6E Reader Code 1	7E Reader Code 2	8E Reader Code 3	9E Au-toTime Code
1 (Master)	P201E	123	ON	ON							
2	P202E		ON								
3	P203E		ON								
4	P204E		ON								
5	P205E		ON								
6	P206E		ON								
7	P207E		ON								
8	P208E		ON								
9	P209E		ON								
10	P210E		ON								
11	P211E		ON								
12	P212E		ON								
13	P213E		ON								
14	P214E		ON								
15	P215E		ON								
16	P216E		ON								
17	P217E		ON								
18	P218E		ON								
19	P219E		ON								
20	P220E		ON								
21	P221E		ON								
22	P222E		ON								
23	P223E		ON								
24	P224E		ON								
25	P225E		ON								
26	P226E		ON								
27	P227E		ON								
28	P228E		ON								
29	P229E		ON								
30	P230E		ON								
31	P231E		ON								
32	P232E		ON								
33	P233E		ON								
34	P234E		ON								
35	P235E		ON								
36	P236E		ON								
37	P237E		ON								
38	P238E		ON								
39	P239E		ON								
40	P240E		ON								
41	P241E		ON								
42	P242E		ON								
43	P243E		ON								
44	P244E		ON								
45	P245E		ON								
46	P246E		ON								
47	P247E		ON								
48	P248E		ON								
49	P249E		ON								
50	P250E		ON								
51	P251E		ON								
52	P252E		ON								
53	P253E		ON								
54	P254E		ON								
55	P255E		ON								
56	P256E		ON								

USER CODES

ASSIGNING EXTRA OPTIONS

Each user code has several "extra options" which can be assigned when programming the code or at any time later.

In **NORMAL USER CODE PROGRAMMING mode** you can do the following:

- Program Keypad Codes (see page 18).
- Program Radio Codes (see page 65).
- Program Access cards (see page 68).
- View radio signal strength (see page 63).

In **EXTRA OPTIONS mode** you can assign several powerful functions to each user code. See below.

To view and program the Extra Options:

- KPX+** 1. Select a User Code (P201–P256E)
- 2. Press EXCLUDE E. *The Exclude light turns ON.*
- NAVIGATOR** Press Extra Code Options.

The following Extra Options can now be changed:

- 1E AREA 1 CODES.** Assign/remove user codes to Area 1. (By default all user codes are assigned to Area 1.)
- 2E AREA 2 CODES.** Assign/remove user codes to Area 2.
 - ⓘ User codes can be assigned to Area 1, Area 2, both areas or no areas.
 - ⓘ An Area will not arm unless it has one or more zones assigned to it (P45E, P46E).
 - ⓘ If a code is not assigned to any Area/s, the code can be used for special functions such as to trigger outputs.
- 3E ARM ONLY.** User Codes 2–56 can be programmed to Arm but not Disarm the panel. (See page 18).
- 4E "CODE ONLY" ARMING.** Enables selected user codes to allow "code only arming". Arming can then be done with or without the use of the arm key on the keypad.
 - ⓘ In the case of radio codes the radio key OFF button will toggle the armed state of the area assigned to the radio key.
 - ⓘ If the User code is assigned to both AREA 1 and AREA 2. If AREA 1 is already armed, then entering the code will disarm AREA 1 - but arm AREA 2.

If the intention is to either ARM or DISARM both areas using this code then ARM + [code] must be used first to arm both areas. Once both are armed they can be disarmed.

 - ⓘ If in Home mode, the action is to exit Home mode.
 - ⓘ Codes selected for Code Only Arming and not assigned to any areas are automatically REX codes. See page 67.
- 5E RADIO CODE.** Enables selected user codes as Radio Codes for operation by Ness Radio Key or Radio Keypad. (Page 65 - how to program Radio Codes).
- 6E READER CODE 1.** Enables user codes as Access Control codes assigned to Reader 1.
- 7E READER CODE 2.** Enables user codes as Access Control codes assigned to Reader 2.
- 8E READER CODE 3.** Enables user codes as Access Control codes assigned to Reader 3.
 - ⓘ A user code can be assigned to any one, two or all three access control readers.
- 9E ENABLE FOR AUTOTIME.** Enables user codes for use by AutoTime. (See page 61, Enable/Disable User Codes Via AutoTimer).

PROGRAMMING

Option No.	Description	Default	
P01E	5E	Enable Remote Panel Tamper	OFF
	13E	Enable Remote Panel Low Battery	OFF
	14E	Enable Remote Panel Mains Fail	OFF
	15E	Enable Remote Panel Comms Fail	OFF
P02E	Remote Comms Key	1234	
P03E	Remote Comms Count	5678	

P01E 5E	ENABLE REMOTE PANEL TAMPER				
<p>PROGRAM MODE LEVEL Installer</p> <p>FACTORY DEFAULT OFF</p> <p>RELATED OPTIONS (Refer to the separate Comms Manual) P92E, P93E Report Misc Remote Alarms & Restorals by CID P196E, P197E Report Misc Remote Alarms & Restorals by SMS</p>	<p>Enables Remote Panel Tamper.</p> <p>Remote Panel Tamper is the 2-pin Internal Tamper header on the optional R16 board and can be disabled if not being used.</p> <table border="1" style="width: 100%;"> <tr> <td style="background-color: #FF69B4;">KPX+</td> <td>P01E 5E to enable/disable the option</td> </tr> <tr> <td style="background-color: #3CB371;">NAVIGATOR</td> <td>P01E 5E to enable/disable the option</td> </tr> </table>	KPX+	P01E 5E to enable/disable the option	NAVIGATOR	P01E 5E to enable/disable the option
KPX+	P01E 5E to enable/disable the option				
NAVIGATOR	P01E 5E to enable/disable the option				
P01E 13E 14E	ENABLE REMOTE PANEL LOW BATTERY & MAINS FAIL				
<p>PROGRAM MODE LEVEL Installer</p> <p>FACTORY DEFAULT OFF</p> <p>RELATED OPTIONS (Refer to the separate Comms Manual) P92E, P93E Report Misc Remote Alarms & Restorals by CID P196E, P197E Report Misc Remote Alarms & Restorals by SMS</p>	<p>13E: Enables Remote Panel Low Battery 14E: Enables Remote Panel Mains Fail</p> <p>Enable both options if the R16 expander is being powered by a local power supply and backup battery and you wish to monitor mains fail and low battery.</p> <p>Disable both options if the expander is being powered by the main board via the 4-wire bus.</p> <table border="1" style="width: 100%;"> <tr> <td style="background-color: #FF69B4;">KPX+</td> <td>P01E 13E or 14E to enable/disable the option</td> </tr> <tr> <td style="background-color: #3CB371;">NAVIGATOR</td> <td>P01E 13E or 14E to enable/disable the option</td> </tr> </table>	KPX+	P01E 13E or 14E to enable/disable the option	NAVIGATOR	P01E 13E or 14E to enable/disable the option
KPX+	P01E 13E or 14E to enable/disable the option				
NAVIGATOR	P01E 13E or 14E to enable/disable the option				
P01E 15E	ENABLE REMOTE PANEL COMMS FAIL				
<p>PROGRAM MODE LEVEL Installer</p> <p>FACTORY DEFAULT OFF</p> <p>RELATED OPTIONS (Refer to the separate Comms Manual) P92E, P93E Report Misc Remote Alarms & Restorals by CID P196E, P197E Report Misc Remote Alarms & Restorals by SMS</p>	<p>Enable the option to allow remote expander data bus comms failures to generate alarms.</p> <table border="1" style="width: 100%;"> <tr> <td style="background-color: #FF69B4;">KPX+</td> <td>P01E 15E to enable/disable the option</td> </tr> <tr> <td style="background-color: #3CB371;">NAVIGATOR</td> <td>P01E 15E to enable/disable the option</td> </tr> </table>	KPX+	P01E 15E to enable/disable the option	NAVIGATOR	P01E 15E to enable/disable the option
KPX+	P01E 15E to enable/disable the option				
NAVIGATOR	P01E 15E to enable/disable the option				
P02E	REMOTE COMMS KEY *Once-only programming				
<p>PROGRAM MODE LEVEL Installer</p> <p>FACTORY DEFAULT 1234</p> <p>NOTES This program option can also accept data in Decimal or Hexadecimal format at the installer's choice. See page 80, how to program in Hex.</p>	<p>For added security of the remote expander data bus, enter a random 4 digit key to establish a security code between the main board and the R16 remote expander. The code forms the basis of a rolling code for data bus security and only needs to be programmed once.</p> <p>Ness recommends that the Comms Key should be changed at the time of installation.</p> <table border="1" style="width: 100%;"> <tr> <td style="background-color: #FF69B4;">KPX+</td> <td>P02E [New 4 digit key] E (Any random digits 0-9, or Hex, see notes)</td> </tr> <tr> <td style="background-color: #3CB371;">NAVIGATOR</td> <td>P02E [New 4 digit key] E (Any random digits 0-9, or Hex, see notes)</td> </tr> </table>	KPX+	P02E [New 4 digit key] E (Any random digits 0-9, or Hex, see notes)	NAVIGATOR	P02E [New 4 digit key] E (Any random digits 0-9, or Hex, see notes)
KPX+	P02E [New 4 digit key] E (Any random digits 0-9, or Hex, see notes)				
NAVIGATOR	P02E [New 4 digit key] E (Any random digits 0-9, or Hex, see notes)				
P03E	REMOTE COMMS COUNT/ROLLING CODE *Once-only programming				
<p>PROGRAM MODE LEVEL Installer</p> <p>FACTORY DEFAULT 5678</p> <p>NOTES This program option can also accept data in Decimal or Hexadecimal format at the installer's choice. See page 80, how to program in Hex.</p>	<p>Enter a random 4 digit number to establish the initial rolling code between the main board and the R16 remote expander.</p> <p>Ness recommends that the Comms Count should be changed at the time of installation.</p> <table border="1" style="width: 100%;"> <tr> <td style="background-color: #FF69B4;">KPX+</td> <td>P03E [New 4 digit key] E (Any random digits 0-9, or Hex, see notes)</td> </tr> <tr> <td style="background-color: #3CB371;">NAVIGATOR</td> <td>P03E [New 4 digit key] E (Any random digits 0-9, or Hex, see notes)</td> </tr> </table>	KPX+	P03E [New 4 digit key] E (Any random digits 0-9, or Hex, see notes)	NAVIGATOR	P03E [New 4 digit key] E (Any random digits 0-9, or Hex, see notes)
KPX+	P03E [New 4 digit key] E (Any random digits 0-9, or Hex, see notes)				
NAVIGATOR	P03E [New 4 digit key] E (Any random digits 0-9, or Hex, see notes)				

Option No.	Description	Default	Note
P26E	Entry Delay Time 1	20	seconds
P27E	Entry Delay Time 2	6	x10 = 60seconds
P28E	Exit Delay Time	60	seconds
P29E	Siren Reset time	5	minutes

P26E	ENTRY DELAY TIME1						
<p>PROGRAM MODE LEVEL User, Installer</p> <p>FACTORY DEFAULT 20 (seconds)</p> <p>NOTES</p> <ul style="list-style-type: none"> • Programmable from 1 – 99 seconds. • The Entry Delay Time also sets the delay before Auto Re-Arming. <p>RELATED OPTIONS P120E 7E Entry Delay Extender</p>	<p>Entry Delay Time 1 is the time given to disarm the panel after an Entry Delay 1 zone is unsecured.</p> <p>Entry Delay Time1 can be from 1 to 99 seconds in 1 second increments. Enable option P120E 7E Entry Delay Extender for maximum of 990 seconds.</p> <table border="1"> <tr> <td style="background-color: #FF00FF;">KPX+</td> <td>P26E [New Time] E</td> </tr> <tr> <td style="background-color: #00FF00;">NAVIGATOR</td> <td>Entry/Exit Delay > Entry Delay Time 1 > Enter new time E</td> </tr> <tr> <td style="background-color: #00BFFF;">SMS*</td> <td>P[MasterCode]E P26E [NewTime]E</td> </tr> </table>	KPX+	P26E [New Time] E	NAVIGATOR	Entry/Exit Delay > Entry Delay Time 1 > Enter new time E	SMS*	P[MasterCode]E P26E [NewTime]E
KPX+	P26E [New Time] E						
NAVIGATOR	Entry/Exit Delay > Entry Delay Time 1 > Enter new time E						
SMS*	P[MasterCode]E P26E [NewTime]E						
P27E	ENTRY DELAY TIME2						
<p>PROGRAM MODE LEVEL User, Installer</p> <p>FACTORY DEFAULT 6 (=60sec)</p> <p>NOTES Programmable from 10 – 990 seconds</p>	<p>Entry Delay Time2 is the time given to disarm the panel after an Entry Delay2 zone is unsecured.</p> <p>The Entry Delay Time2 setting is from 10 to 990 seconds (1 – 99).</p> <p>Note: The Entry Delay Time2 is set in 10 second increments so that a value setting of 6 means a 60 seconds delay.</p> <table border="1"> <tr> <td style="background-color: #FF00FF;">KPX+</td> <td>P27E [New Time] E</td> </tr> <tr> <td style="background-color: #00FF00;">NAVIGATOR</td> <td>Entry/Exit Delay > Entry Delay Time 2 > Enter new time E</td> </tr> <tr> <td style="background-color: #00BFFF;">SMS*</td> <td>P[MasterCode]E P27E [NewTime]E</td> </tr> </table>	KPX+	P27E [New Time] E	NAVIGATOR	Entry/Exit Delay > Entry Delay Time 2 > Enter new time E	SMS*	P[MasterCode]E P27E [NewTime]E
KPX+	P27E [New Time] E						
NAVIGATOR	Entry/Exit Delay > Entry Delay Time 2 > Enter new time E						
SMS*	P[MasterCode]E P27E [NewTime]E						
P28E	EXIT DELAY TIME						
<p>PROGRAM MODE LEVEL User, Installer</p> <p>FACTORY DEFAULT 60 (seconds)</p> <p>NOTES</p> <ul style="list-style-type: none"> • Programmable from 1 – 99 seconds <p>RELATED OPTIONS: P62E 8E Exit Time x10</p>	<p>Exit Delay Time is the time given to secure and depart the premises after the panel is armed. All zones (except 24hr zones) are inactive during the Exit Delay time.</p> <p>The Exit Delay Time setting is from 1 to 99 seconds in 1 second increments.</p> <table border="1"> <tr> <td style="background-color: #FF00FF;">KPX+</td> <td>P28E [New Time] E</td> </tr> <tr> <td style="background-color: #00FF00;">NAVIGATOR</td> <td>Entry/Exit Delay > Exit Delay Time 1 > Enter new time E</td> </tr> <tr> <td style="background-color: #00BFFF;">SMS*</td> <td>P[MasterCode]E P28E [NewTime]E</td> </tr> </table>	KPX+	P28E [New Time] E	NAVIGATOR	Entry/Exit Delay > Exit Delay Time 1 > Enter new time E	SMS*	P[MasterCode]E P28E [NewTime]E
KPX+	P28E [New Time] E						
NAVIGATOR	Entry/Exit Delay > Exit Delay Time 1 > Enter new time E						
SMS*	P[MasterCode]E P28E [NewTime]E						
P29E	SIREN RESET TIME						
<p>PROGRAM MODE LEVEL Installer</p> <p>FACTORY DEFAULT 5 (minutes)</p> <p>NOTES</p> <ul style="list-style-type: none"> • Programmable from 1 – 99 minutes. • Siren times of longer than 5 minutes are contrary to noise pollution regulations in most areas. 	<p>Siren Reset Time sets the duration of the Siren and Reset outputs.</p> <p>Programmable from 1 to 99 minutes in 1 minute increments.</p> <table border="1"> <tr> <td style="background-color: #FF00FF;">KPX+</td> <td>P29E [New Time] E</td> </tr> <tr> <td style="background-color: #00FF00;">NAVIGATOR</td> <td>P29E > Siren Reset Time > Enter new time E</td> </tr> <tr> <td style="background-color: #00BFFF;">SMS*</td> <td>P[MasterCode]E P[InstallerCode]E P29E [NewTime]E</td> </tr> </table>	KPX+	P29E [New Time] E	NAVIGATOR	P29E > Siren Reset Time > Enter new time E	SMS*	P[MasterCode]E P[InstallerCode]E P29E [NewTime]E
KPX+	P29E [New Time] E						
NAVIGATOR	P29E > Siren Reset Time > Enter new time E						
SMS*	P[MasterCode]E P[InstallerCode]E P29E [NewTime]E						

* SMS programming and operation requires the optional 106-985 4G Module

PROGRAMMING

Option No.	Description	ZONES 1-8								ZONES 9-32 IF FITTED							
		1	2	3	4	5	6	7	8	9	10	11	31	31	32
P30E	NORMAL	ON	ON	ON	ON	ON	ON	ON	ON								
VIBRATION OPTIONS	P31E	Vibration EXTREME*															
	P32E	Vibration HIGHEST															
	P33E	Vibration HIGH															
	P34E	Vibration MEDIUM															
	P35E	Vibration LOWER															
	P36E	Vibration LOWEST															
P37E	1 second ZONES																
P38E	3 second ZONES																

* Extreme sensitivity (P31E) **should not be used**. It is provided as a guide only.

P30E – P36E	VIBRATION SENSITIVITY						
<p>PROGRAM MODE LEVEL Installer</p> <p>FACTORY DEFAULT Normal sensitivity. P30E, all zones = ON</p> <p>NOTES</p> <ul style="list-style-type: none"> Sensitivity can be individually programmed for each zone. Zones are allocated to one sensitivity level at any one time. Turning a zone ON in a sensitivity level, turns the zone OFF in any other sensitivity level. To revert zone sensitivity back to Normal, turn on the required zone/s at P30E. 	<p>Each zone has individually adjustable sensitivity for connection of Nessensor Vibration Sensors. Zone sensitivity is adjusted by toggling zones ON in options P30E to P36E. P30E is Normal Sensitivity, vibration analyser disabled. This is used for normal alarm devices. Zone response time, 200ms.</p> <p>P31–36E are the options for the 6 levels of vibration sensitivities. P31E is the most sensitive setting.</p> <table border="1" style="width: 100%;"> <tr> <td style="background-color: #FF00FF; color: white;">KPX+</td> <td>P30E ~ P36E [Zone Number] E to enable a sensitivity level per zone</td> </tr> <tr> <td style="background-color: #00FF00; color: white;">NAVIGATOR</td> <td>P30E > View Zones > Select zones (Press Next/Previous Option)</td> </tr> <tr> <td style="background-color: #0000FF; color: white;">SMS*</td> <td>P[MasterCode]E P[InstallerCode]E P30E [Zone Number] E eg. Zones 3 & 4 to be Medium sensitivity P[MasterCode]E P[InstallerCode]E P34E 3E 4E</td> </tr> </table>	KPX+	P30E ~ P36E [Zone Number] E to enable a sensitivity level per zone	NAVIGATOR	P30E > View Zones > Select zones (Press Next/Previous Option)	SMS*	P[MasterCode]E P[InstallerCode]E P30E [Zone Number] E eg. Zones 3 & 4 to be Medium sensitivity P[MasterCode]E P[InstallerCode]E P34E 3E 4E
KPX+	P30E ~ P36E [Zone Number] E to enable a sensitivity level per zone						
NAVIGATOR	P30E > View Zones > Select zones (Press Next/Previous Option)						
SMS*	P[MasterCode]E P[InstallerCode]E P30E [Zone Number] E eg. Zones 3 & 4 to be Medium sensitivity P[MasterCode]E P[InstallerCode]E P34E 3E 4E						
P37E – P38E	LONG RESPONSE ZONES						
<p>PROGRAM MODE LEVEL Installer</p> <p>FACTORY DEFAULT all off</p> <p>NOTES</p> <ul style="list-style-type: none"> A Long Response Zone cannot be a Normal Zone or Vibration zone at the same time. To convert zone/s back to a Normal Zone, turn on the required zone/s at P30E. <p>RELATED OPTIONS P301E 5E-7E Request To Exit (REX)</p>	<p>Long Response Zones are normal alarm zones with a long reaction time. Individual zones can be programmed to have either a 1 second response (P37E) or 3 second response (P38E).</p> <p>This is useful where zones 5, 6 or 7 have been programmed as REX inputs for access control purposes, (P301E 5E-7E). To prevent accidental door opening, the REX button then must be pressed and held for 1sec or 3sec, as programmed.</p> <table border="1" style="width: 100%;"> <tr> <td style="background-color: #FF00FF; color: white;">KPX+</td> <td>P37E ~ P38E> Enter [Zone Number] E to enable that sensitivity</td> </tr> <tr> <td style="background-color: #00FF00; color: white;">NAVIGATOR</td> <td>P37E > View Zones > Select zones (Press Next/Previous Option)</td> </tr> <tr> <td style="background-color: #0000FF; color: white;">SMS*</td> <td>P[MasterCode]E P[InstallerCode]E P37E [Zone Number] E</td> </tr> </table>	KPX+	P37E ~ P38E> Enter [Zone Number] E to enable that sensitivity	NAVIGATOR	P37E > View Zones > Select zones (Press Next/Previous Option)	SMS*	P[MasterCode]E P[InstallerCode]E P37E [Zone Number] E
KPX+	P37E ~ P38E> Enter [Zone Number] E to enable that sensitivity						
NAVIGATOR	P37E > View Zones > Select zones (Press Next/Previous Option)						
SMS*	P[MasterCode]E P[InstallerCode]E P37E [Zone Number] E						

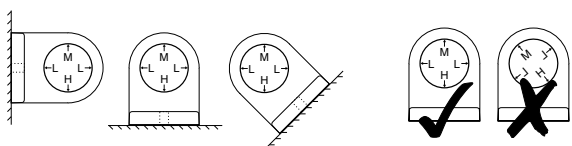
<p>i</p> <p>ADJUSTING NESSENSORS</p> <p>Nessensors are sensitive to high frequencies and insensitive to low frequencies. Therefore it is not necessary to apply much force to the protected structure, rather a very rapid succession of blows.</p> <p>The sensitivity has been correctly adjusted when a single blow applied with a soft object (e.g. by hand) does not cause an alarm whereas a rapid series of blows (using a metal object such as a screwdriver blade) will cause an alarm.</p>	<p>NESSENSOR™ Vibration Sensor Part No. VIB500</p> <p>In addition to zone sensitivity adjustment, the overall sensitivity of the Nessensor can be adjusted by rotating the body of the Nessensor within its bracket.</p> <div style="display: flex; align-items: center;">  <div style="margin-left: 20px;"> <p>The Nessensor bracket must always be mounted horizontally and the arrow must point up for any required setting.</p> </div> </div>
---	---

* SMS programming and operation requires the optional 106-985 4G Module

Option No.	Description	ZONES 1-8								ZONES 9-32 IF FITTED							
		1	2	3	4	5	6	7	8	9	10	11	31	31	32
P39E	DOUBLE TRIGGER zones																
P40E	INSTANT zones			ON	ON	ON	ON	ON	ON	ON	ON	ON	ON	ON	ON	ON	ON
P41E	ENTRY DELAY 1 zones	ON															
P42E	HANDOVER zones		ON														
P43E	ENTRY DELAY 2 zones																
P44E	LOCKOUT zones (Reset O/P)	ON	ON	ON	ON	ON	ON	ON	ON	ON	ON	ON	ON	ON	ON	ON	
P45E	AREA 1 zones	ON	ON	ON	ON	ON	ON	ON	ON	ON	ON	ON	ON	ON	ON	ON	
P46E	AREA 2 zones																
P51E	HOME zones																
P52E	24HR zones																
P53E	DAY zones																

ZONE DELAY TYPES

Only one option per zone can be selected. For example; a zone cannot be instant and delayed at the same.

P39E

DOUBLE TRIGGER ZONES

PROGRAM MODE LEVEL

Installer

FACTORY DEFAULT

All OFF: No Double Trigger zones.

NOTES

- Double Trigger is useful for preventing unwanted alarms from zones in harsh environments such as sheds and garages.
- (KPX+) 0E will turn all selections OFF.
- MEMORY E will turn all selections ON.

Zones programmed to Double Trigger will recognise an alarm condition if:

- The zone has been triggered twice within a 4 minute period.
- If any 2 zones (both programmed for double trigger), each trigger once.
- The zone is left unsealed for longer than 15 seconds.

KPX+	P39E [Zone Number] E to enable/disable zones
NAVIGATOR	P39E > Select zones
SMS*	P[MasterCode]E P[InstallerCode]E P39E [Zone Number] E

P40E

INSTANT ZONES

PROGRAM MODE LEVEL

Installer

FACTORY DEFAULT

Zones 3-32 Instant.

NOTES

When a zone is selected for this type, it is automatically deselected from any other zone type in the DELAY GROUP.

RELATED OPTIONS

P41E, P42E, P43E

Instant Zones operate only in the Armed state. When Armed at the expiry of exit time, Instant Zones will activate assigned outputs immediately when triggered.

KPX+	P40E [Zone Number] E to enable zones
NAVIGATOR	P40E > Select zones
SMS*	P[MasterCode]E P[InstallerCode]E P40E [Zone Number] E

P41E

ENTRY DELAY1 ZONES

PROGRAM MODE LEVEL

Installer

FACTORY DEFAULT

1E ON: Zone 1 has Entry Delay1.

NOTES

When a zone is selected for this type, it is automatically deselected from any other zone type in the DELAY GROUP.

RELATED OPTIONS

P60E 1E Entry Beeps
P40E, P42E, P43E

Entry Delay1 zones operate only in the Armed state. When Armed, at the expiry of exit time these zones will activate the Entry Delay Timer1 (P26E) when they are triggered. If the panel is not disarmed before the expiry of the Entry Delay Timer1, the alarm outputs will be activated.

KPX+	P41E [Zone Number] E to enable zones
NAVIGATOR	P41E > Select zones
SMS*	P[MasterCode]E P[InstallerCode]E P41E [Zone Number] E

* SMS programming and operation requires the optional 106-985 4G Module

PROGRAMMING

P42E	HANDOVER ZONES						
<p>PROGRAM MODE LEVEL Installer</p> <p>FACTORY DEFAULT 2E ON: Zone 2 is a Handover zone.</p> <p>NOTES When a zone is selected for this type, it is automatically deselected from any other zone type in the DELAY GROUP.</p> <p>RELATED OPTIONS P40E, P41E, P43E</p>	<p>Handover zones are delayed only if entry is made through an Entry Delay zone first. If a Handover zone is triggered first, the zone behaves as an instant zone. Normally, the “point of entry” zone should be Delay zone, with any other zones in the entry path programmed as Handover zones.</p> <table border="1"> <tr> <td style="background-color: #FF00FF; color: white;">KPX+</td> <td>P42E [Zone Number] E to enable zones</td> </tr> <tr> <td style="background-color: #00FF00; color: white;">NAVIGATOR</td> <td>P42E > Select zones</td> </tr> <tr> <td style="background-color: #00BFFF; color: white;">SMS*</td> <td>P[MasterCode]E P[InstallerCode]E P42E [Zone Number] E</td> </tr> </table>	KPX+	P42E [Zone Number] E to enable zones	NAVIGATOR	P42E > Select zones	SMS*	P[MasterCode]E P[InstallerCode]E P42E [Zone Number] E
KPX+	P42E [Zone Number] E to enable zones						
NAVIGATOR	P42E > Select zones						
SMS*	P[MasterCode]E P[InstallerCode]E P42E [Zone Number] E						
P43E	ENTRY DELAY2 ZONES						
<p>PROGRAM MODE LEVEL Installer</p> <p>FACTORY DEFAULT All OFF: No zones have Entry Delay2.</p> <p>NOTES When a zone is selected for this type, it is automatically deselected from any other zone type in the DELAY GROUP.</p> <p>RELATED OPTIONS P40E, P41E, P42E</p>	<p>When an Entry Delay2 zone is triggered, it has entry delay as set by the Entry Delay Time2 (P27E).</p> <table border="1"> <tr> <td style="background-color: #FF00FF; color: white;">KPX+</td> <td>P43E [Zone Number] E to enable zones</td> </tr> <tr> <td style="background-color: #00FF00; color: white;">NAVIGATOR</td> <td>P43E > Select zones</td> </tr> <tr> <td style="background-color: #00BFFF; color: white;">SMS*</td> <td>P[MasterCode]E P[InstallerCode]E P43E [Zone Number] E</td> </tr> </table>	KPX+	P43E [Zone Number] E to enable zones	NAVIGATOR	P43E > Select zones	SMS*	P[MasterCode]E P[InstallerCode]E P43E [Zone Number] E
KPX+	P43E [Zone Number] E to enable zones						
NAVIGATOR	P43E > Select zones						
SMS*	P[MasterCode]E P[InstallerCode]E P43E [Zone Number] E						
P44E	RESET LOCKOUT ZONES						
<p>PROGRAM MODE LEVEL Installer</p> <p>FACTORY DEFAULT All ON: All zones are Lockout zones.</p> <p>NOTES When a zone is selected for this type, it is automatically deselected from any other zone type in the DELAY GROUP.</p> <p style="background-color: #FF00FF; color: white; padding: 2px;">KPX+ PRO TIP</p> <p>When selecting zones, MEMORY E selects all, 0 E deselects all.</p> <p>RELATED OPTIONS P60E 4E Tamper Reset Lockout. P78E Multiple alarm reports.</p>	<p>All zones and tamper input can be programmed to Lockout, i.e. cause the RESET OUTPUT to sound only once while the panel is armed.</p> <p>The RESET OUTPUT is then locked out for that alarmed zone until entering a valid code has reset the panel. If using area partitioning, disarming either partition resets the zone lockout for both partitions.</p> <table border="1"> <tr> <td style="background-color: #FF00FF; color: white;">KPX+</td> <td>P44E [Zone Number] E to enable/disable zones</td> </tr> <tr> <td style="background-color: #00FF00; color: white;">NAVIGATOR</td> <td>P44E > Select zones</td> </tr> <tr> <td style="background-color: #00BFFF; color: white;">SMS*</td> <td>P[MasterCode]E P[InstallerCode]E P44E [Zone Number]E</td> </tr> </table>	KPX+	P44E [Zone Number] E to enable/disable zones	NAVIGATOR	P44E > Select zones	SMS*	P[MasterCode]E P[InstallerCode]E P44E [Zone Number]E
KPX+	P44E [Zone Number] E to enable/disable zones						
NAVIGATOR	P44E > Select zones						
SMS*	P[MasterCode]E P[InstallerCode]E P44E [Zone Number]E						

AREA PARTITIONING

ASSIGNING ZONES TO AREAS		ZONES 1-8								ZONES 9-32 IF FITTED							
		1	2	3	4	5	6	7	8	9	10	11	31	31	32
P45E	AREA 1 ZONES	ON	ON	ON	ON	ON	ON	ON	ON	ON	ON	ON	ON	ON	ON	ON	ON
P46E	AREA 2 ZONES																

P45E, P46E	ASSIGNING ZONES TO AREAS						
<p>PROGRAM MODE LEVEL Installer</p> <p>FACTORY DEFAULT All zones assigned to Area 1. No zones assigned to Area 2.</p> <p>NOTES</p> <ul style="list-style-type: none"> Zones assigned to BOTH areas become Common zones. If no Area operation is required, assign all zones to Area 1. (This is also the factory default). 	<p>Assign (or remove) zones that will operate in Area 1 and/or Area 2.</p> <table border="1"> <tr> <td style="background-color: #FF00FF; color: white;">KPX+</td> <td>P45E [Zone Number] E to enable/disable zones for Area 1 P46E [Zone Number] E to enable/disable zones for Area 2</td> </tr> <tr> <td style="background-color: #00FF00; color: white;">NAVIGATOR</td> <td>P45E > Select zones (Press Next/Previous Option) P46E > Select zones (Press Next/Previous Option)</td> </tr> <tr> <td style="background-color: #00BFFF; color: white;">SMS*</td> <td>P[MasterCode]E P[InstallerCode]E P45E [Zone Number]E P[MasterCode]E P[InstallerCode]E P46E [Zone Number]E</td> </tr> </table>	KPX+	P45E [Zone Number] E to enable/disable zones for Area 1 P46E [Zone Number] E to enable/disable zones for Area 2	NAVIGATOR	P45E > Select zones (Press Next/Previous Option) P46E > Select zones (Press Next/Previous Option)	SMS*	P[MasterCode]E P[InstallerCode]E P45E [Zone Number]E P[MasterCode]E P[InstallerCode]E P46E [Zone Number]E
KPX+	P45E [Zone Number] E to enable/disable zones for Area 1 P46E [Zone Number] E to enable/disable zones for Area 2						
NAVIGATOR	P45E > Select zones (Press Next/Previous Option) P46E > Select zones (Press Next/Previous Option)						
SMS*	P[MasterCode]E P[InstallerCode]E P45E [Zone Number]E P[MasterCode]E P[InstallerCode]E P46E [Zone Number]E						

* SMS programming and operation requires the optional 106-985 4G Module

AREA PARTITIONING

DEFINITION

Area Partitioning allows the control panel zones to be split into two partitions; Area1 and Area2. The panel then effectively operates as two separate systems sharing only the siren outputs and communicator.

COMMON AREA ZONES

Zones assigned to both Areas are armed only when Area1 and Area2 are both armed. This allows the Common Area zone/s to be shared by both Areas.

For example, Office A and Office B operate as separate areas but the entrance foyer used by both offices is assigned to both areas meaning it will automatically arm when both Areas have armed. The Common Area then automatically disarms when either Area1 or Area2 disarms.

USER CODE ASSIGNMENT

A User Code assigned to an Area can arm and disarm only that Area. User Codes assigned to both Areas will operate both Areas simultaneously.

OPERATION

Arming and disarming is carried out as normal from a single keypad or separate keypads installed in both areas or by Radio Key.

Area operation only applies to zones when they are in the armed state. This means that Day zones and 24hr zones are independent of area operations.

AREA PARTITIONING & HOME MODE

The panel can be armed in Home mode if Area2 is already armed on these conditions:

1. Area 1 must be OFF.
2. Area 2 must be armed first, and then Home armed – not the reverse.
3. Zones assigned to both Home mode (P51E) and to Area 2 (P46E) will act as Home zones when both Area 2 and Home are armed.
4. Zones must be assigned to P51E to allow Home arm.
5. User codes assigned only to Area2 can arm but **will not disarm Home Mode**.

Note: Home arming when AREA 2 is armed cannot be done by Radio Key (double OFF button) or by keyswitch.

Note: Home Mode is not available when Area 1 is armed.

HOME MODE

Home Mode allows selected zones to be armed while the system is disarmed. For example, this is often used to arm door and windows sensors overnight, while allowing free movement within the premises.

1. Home Mode will not arm if Area 1 is armed.
2. Home Mode will not arm if there are no Home zones programmed, (P51E).
3. User codes assigned only to Area2 can arm but will not disarm Home Mode.
4. Zones which are to be armed in Home Mode are selected using option P51E.
5. Home Mode can be armed by Keypad, Radio Key or Access Card.
6. Audible outputs in Home Mode (set by options P63E 1E-4E) are independent of audible outputs in fully armed mode.
7. If reporting is enabled, Home Mode alarms will be reported as normal providing that:
 - a/ The zone/s are selected to report alarms by option P74E.
 - b/ Options P64E 1E & 3E are off. (Brief Home Alarm, Home Entry Delay2).
8. Zones selected to be Entry Delay1 zones also have entry delay in Home Mode.
9. If Home Zones Entry Delay2 (P64E 3E) is enabled, then *all* Home zones will have entry delay as set by P27E.

TEMPORARY DAY ZONES OPERATION (KPX+ and Navigator)

The Temporary Day Zone feature allows easy and flexible Day Zone selection and operation.

While remaining in normal operating mode, the user can add and remove Temporary Day Zones and enable/disable day zone operation using simple key strokes.

TO ENABLE TEMPORARY DAY ZONES

To enable Temporary Day Zone selection and operation, the Brief Day Alarm feature (installer option P64E 2E) must be ON. If P64E 2E is OFF, the Temporary Day Zone feature will be unavailable but Permanent Day Zones will still operate and will sound the programmed output while the zone is unsealed.

P64E 2E is OFF by default.

USER COMMANDS (In normal Operating Mode).

(P) + (E) Selection Mode. Enter **P** followed by **E** when in operating mode to enter Temporary Day Zone selection mode.

[Zone No.] + (E) Zone Selection. To select or deselect zones to be Temporary Day Zones. The selected zones are indicated by the corresponding zone number.

Permanent Day Zones, (set by installer option P53E), are not displayed in selection mode. Permanent Day Zones can be selected as Temporary Day Zones but this has no effect as those zones are already day zones.

(E) Saves changes and returns to normal operating mode.

(O) + (E) Enables and Disables Day Mode. This enables/disables both Temporary and Permanent Day Zones.

INDICATION

The Home icon flashes continuously when Temporary Day Mode is enabled.

OPERATION

When Day Mode is enabled, any unsealed day zone will sound the programmed output for 2 seconds. When Day Mode is disabled, an unsealed day zone will simply be indicated on the keypad as an unsealed zone.

KPX CHIME

The KPX keypad has a special two tone chime which can be enabled in place of the default beep warning tone. See P126E 4E.

AUX 2 OPTION

When the Temporary Day Zone feature is enabled, the installer option P63E 6E selects Aux 2 output instead of the strobe output. This allows a remote warning device such as a buzzer to be connected for day zone warning. This may be needed if an additional audible day zone warning is needed, although the keypad sonalert, (P63E 7E), is more than adequate in most cases.

RELATED OPTIONS

P64E 2E, Brief Day Alarm. Turn this option on to enable Temporary Day Zones. Factory default = OFF.

P63E 5E, Day Mode to Reset output.

P63E 6E, Day Mode to Strobe output.

If P64E 2E is ON, then this option sends day alarms to the AUX 2 output.

P63E 7E, Day Mode to Sonalert.

P63E 8E, Day Mode to Siren output.

P53E, Permanent Day Zone selection.

P126E 4E, Enable KPX Chime in Day Mode

(I) Temporary Day Zone selections will be lost if the panel is powered down or reset, but are not affected by arming/disarming or entering program mode.

PROGRAMMING

ASSIGNING ZONES TO AREAS		ZONES 1-8							ZONES 9-32 IF FITTED								
Option No.	Description	1	2	3	4	5	6	7	8	9	10	11	31	31	32
P51E	HOME ZONES																
P52E	24HR ZONES																
P53E	DAY ZONES																

P51E	HOME ZONES						
<p>PROGRAM MODE LEVEL Installer</p> <p>FACTORY DEFAULT all OFF: No Home zones.</p> <p>NOTES By default, all Home zones have Entry Delay2, see P64E 3E. If this option is off Home zones have normal entry delay attributes set by options P40E-P42E.</p> <p>RELATED OPTIONS P63E Home Mode output mapping. P64E 1E Brief Home alarm. P64E 3E Home zones have Entry Delay2. P69E 3E Quiet Home siren. P69E 5E Radio Key ON or OFF button arms Home Mode. P120E 2E Home arm chirps by radio key. P120E 3E Radio Key AUX button arms Home mode. P120E 6E Smart Beeps for Home and Day zones.</p>	<p>Home zones allow you to Arm selected zones while others are ignored. Typically used for perimeter zones such as windows and doors while you are at home.</p> <p>For example: upstairs zones are Disarmed while downstairs zones are Armed in Home mode.</p> <table border="1" style="width: 100%;"> <tr> <td style="background-color: #FF00FF; color: white;">KPX+</td> <td>P51E [Zone Number] E to enable/disable zones</td> </tr> <tr> <td style="background-color: #00FF00; color: white;">NAVIGATOR</td> <td>P51E > Select zones</td> </tr> <tr> <td style="background-color: #00BFFF; color: white;">SMS*</td> <td>P[MasterCode]E P[InstallerCode]E P51E [Zone Number] E</td> </tr> </table> <p>NOTE: Zones selected to Report Zone Alarms (P74E)* will by default report alarms in Home Mode, (if the communicator is enabled).</p> <p>The Brief Home Alarm option P64E 1E, when enabled, prevents Home alarms from reporting.</p> <p>See page 25 for Home Mode operation.</p>	KPX+	P51E [Zone Number] E to enable/disable zones	NAVIGATOR	P51E > Select zones	SMS*	P[MasterCode]E P[InstallerCode]E P51E [Zone Number] E
KPX+	P51E [Zone Number] E to enable/disable zones						
NAVIGATOR	P51E > Select zones						
SMS*	P[MasterCode]E P[InstallerCode]E P51E [Zone Number] E						
P52E	24HR ZONES						
<p>PROGRAM MODE LEVEL Installer</p> <p>FACTORY DEFAULT All OFF: No 24hr zones.</p> <p>NOTES</p> <ul style="list-style-type: none"> The Tamper input is always a 24hr zone. For silent 24hr zones, deselect the zone/s from options P54E-P57E (Reset, Strobe, Sonalert & Siren). To change a 24hr zone to any other zone type, the zone must also be re-assigned to an AREA (P45E or P46E). 	<p>24hr Zones operate at all times regardless of the mode of panel operation, i.e. Armed, Disarmed or Home Monitor. When alarmed, these zones will activate assigned outputs immediately. To reset those alarms a valid user code must be entered.</p> <p>Selecting a zone as 24hr will override any other zone type setting such as Instant, Delayed or Handover. 24hr zones are independent of Area operation. All other zone types must be assigned to at least one Area to become active.</p> <table border="1" style="width: 100%;"> <tr> <td style="background-color: #FF00FF; color: white;">KPX+</td> <td>P52E [Zone Number] E to enable/disable zones</td> </tr> <tr> <td style="background-color: #00FF00; color: white;">NAVIGATOR</td> <td>P52E > Select zones</td> </tr> <tr> <td style="background-color: #00BFFF; color: white;">SMS*</td> <td>P[MasterCode]E P[InstallerCode]E P52E [Zone Number] E</td> </tr> </table>	KPX+	P52E [Zone Number] E to enable/disable zones	NAVIGATOR	P52E > Select zones	SMS*	P[MasterCode]E P[InstallerCode]E P52E [Zone Number] E
KPX+	P52E [Zone Number] E to enable/disable zones						
NAVIGATOR	P52E > Select zones						
SMS*	P[MasterCode]E P[InstallerCode]E P52E [Zone Number] E						
P53E	DAY ZONES						
<p>PROGRAM MODE LEVEL Installer</p> <p>FACTORY DEFAULT All OFF: No Day zones.</p> <p>NOTES Typical uses For Day Zones, Instant alert when a delivery door is opened, doorway alert for a shop.</p> <p>RELATED OPTIONS P63E 5E-8E Day zone output mapping. P64E 2E Brief Day Mode alarm. P120E 6E Smart Beeps for Home and Day zones.</p>	<p>Day Zones operate when the panel is fully disarmed, i.e. when Area 1, Area 2 and Home are all off. When alarmed, these zones will activate their assigned outputs instantly.</p> <p>The outputs mapped to the Day Zone will turn on while the zone is unsealed. Turn P64E 2E on, to limit Day Zone alarms to 2 seconds.</p> <p>Also see Temporary Day Zones feature (page 25) which allows day mode to be easily enabled/disabled and day zones added/removed by the user from any keypad.</p> <table border="1" style="width: 100%;"> <tr> <td style="background-color: #FF00FF; color: white;">KPX+</td> <td>P53E [Zone Number] E to enable/disable zones</td> </tr> <tr> <td style="background-color: #00FF00; color: white;">NAVIGATOR</td> <td>P53E > Select zones</td> </tr> <tr> <td style="background-color: #00BFFF; color: white;">SMS*</td> <td>P[MasterCode]E P[InstallerCode]E P53E [Zone Number] E</td> </tr> </table> <div style="background-color: #D3D3D3; padding: 5px; text-align: center; margin-top: 10px;">See page 25 for information about TEMPORARY DAY ZONES</div>	KPX+	P53E [Zone Number] E to enable/disable zones	NAVIGATOR	P53E > Select zones	SMS*	P[MasterCode]E P[InstallerCode]E P53E [Zone Number] E
KPX+	P53E [Zone Number] E to enable/disable zones						
NAVIGATOR	P53E > Select zones						
SMS*	P[MasterCode]E P[InstallerCode]E P53E [Zone Number] E						

* SMS programming and operation requires the optional 106-985 4G Module

ZONE TO OUTPUT MAPPING

When a zone alarms, it can turn on any or all outputs: Sonalert, Strobe, Siren, Reset, AUX outputs.

The programming is selected with options P54E – P59E. Simply set the zone number to the output to select it. The zone LED will indicate if the zone is selected.

The Tamper Input and the Keypad Panic can be programmed to turn on the Reset, Strobe, Sonalert and Siren by using option P61E.



Zone To Output Mapping applies to zones when the panel is in the Armed or 24hr state. For Home and DAY mode Output Mapping – see Option P63E 1E–8E, page 33.

MAPPING ZONES TO OUTPUTS

Option No.	Description	ZONES 1–8								ZONES 9-32 IF FITTED							
		1	2	3	4	5	6	7	8	9	10	11	31	31	32
P54E	RESET Zones	ON	ON	ON	ON	ON	ON	ON	ON	ON	ON	ON	ON	ON	ON	ON	ON
P55E	STROBE Zones	ON	ON	ON	ON	ON	ON	ON	ON	ON	ON	ON	ON	ON	ON	ON	ON
P56E	SONALERT Zones	ON	ON	ON	ON	ON	ON	ON	ON	ON	ON	ON	ON	ON	ON	ON	ON
P57E	SIREN Zones	ON	ON	ON	ON	ON	ON	ON	ON	ON	ON	ON	ON	ON	ON	ON	ON
P58E	AUX1,3 Zones																
P59E	AUX2,4 Zones																

P54E

RESET OUTPUT ZONES

PROGRAM MODE LEVEL

Installer

FACTORY DEFAULT

All ON: All zones trigger Reset output.

Selects the zones to trigger the Reset output.

KPX+	P54E [Zone Number] E to enable/disable zones
NAVIGATOR	P54E > Select zones
SMS*	P[MasterCode]E P[InstallerCode]E P54E [Zone Number] E

P55E

STROBE OUTPUT ZONES

PROGRAM MODE LEVEL

Installer

FACTORY DEFAULT

All ON: All zones trigger Strobe output.

Selects the zones to trigger the Strobe output.

KPX+	P55E [Zone Number] E to enable/disable zones
NAVIGATOR	P55E > Select zones
SMS*	P[MasterCode]E P[InstallerCode]E P55E [Zone Number] E

P56E

KEYPAD SONALERT ZONES

PROGRAM MODE LEVEL

Installer

FACTORY DEFAULT

All ON: All zones sound the Keypad Sonalert.

Selects the zones to trigger the Keypad Sonalert.

KPX+	P56E [Zone Number] E to enable/disable zones
NAVIGATOR	P56E > Select zones
SMS*	P[MasterCode]E P[InstallerCode]E P56E [Zone Number] E

P57E

SIREN ZONES

PROGRAM MODE LEVEL

Installer

FACTORY DEFAULT

All ON: All zones trigger Siren output

Selects the zones to trigger the Siren output.

KPX+	P57E [Zone Number] E to enable/disable zones
NAVIGATOR	P57E > Select zones
SMS*	P[MasterCode]E P[InstallerCode]E P57E [Zone Number] E

KPX+ PRO TIP

When selecting zones, **MEMORY E** selects all zones, **0 E** deselects all zones

* SMS programming and operation requires the optional 106-985 4G Module

PROGRAMMING

P58E	AUX1,3 OUTPUT ZONES						
<p>PROGRAM MODE LEVEL Installer</p> <p>FACTORY DEFAULT All OFF: No zones trigger AUX 1 or 3</p> <p>RELATED OPTIONS P121E, P123E Day zone output mapping.</p>	<p>Selects the zones to trigger the AUX1 or AUX3 outputs. This option selects which zones trigger AUX1 or 3.</p> <p>Use P121E 1E and/or P123E 1E to enable the ouput.</p> <p>Once turned on by a zone alarm, the output will remain on until the panel is reset/disarmed.</p> <table border="1" style="width: 100%; border-collapse: collapse;"> <tr> <td style="background-color: #FF00FF; color: white; text-align: center;">KPX+</td> <td>P58E [Zone Number] E to enable/disable zones</td> </tr> <tr> <td style="background-color: #00FF00; color: white; text-align: center;">NAVIGATOR</td> <td>P58E > Select zones</td> </tr> <tr> <td style="background-color: #00BFFF; color: white; text-align: center;">SMS*</td> <td>P[MasterCode]E P[InstallerCode]E P58E [Zone Number] E</td> </tr> </table>	KPX+	P58E [Zone Number] E to enable/disable zones	NAVIGATOR	P58E > Select zones	SMS*	P[MasterCode]E P[InstallerCode]E P58E [Zone Number] E
KPX+	P58E [Zone Number] E to enable/disable zones						
NAVIGATOR	P58E > Select zones						
SMS*	P[MasterCode]E P[InstallerCode]E P58E [Zone Number] E						
P59E	AUX2,4 OUTPUT ZONES						
<p>PROGRAM MODE LEVEL Installer</p> <p>FACTORY DEFAULT All OFF: No zones trigger AUX 2 or 4</p> <p>RELATED OPTIONS P121E, P123E Day zone output mapping.</p>	<p>Selects the zones to trigger the AUX2 or AUX4 outputs. This option selects which zones trigger AUX2 or 4.</p> <p>Use P122E 1E and/or P124E 1E to enable the ouput.</p> <p>Once turned on by a zone alarm, the output will remain on until the panel is reset/disarmed.</p> <table border="1" style="width: 100%; border-collapse: collapse;"> <tr> <td style="background-color: #FF00FF; color: white; text-align: center;">KPX+</td> <td>P59E [Zone Number] E to enable/disable zones</td> </tr> <tr> <td style="background-color: #00FF00; color: white; text-align: center;">NAVIGATOR</td> <td>P59E > Select zones</td> </tr> <tr> <td style="background-color: #00BFFF; color: white; text-align: center;">SMS*</td> <td>P[MasterCode]E P[InstallerCode]E P59E [Zone Number] E</td> </tr> </table>	KPX+	P59E [Zone Number] E to enable/disable zones	NAVIGATOR	P59E > Select zones	SMS*	P[MasterCode]E P[InstallerCode]E P59E [Zone Number] E
KPX+	P59E [Zone Number] E to enable/disable zones						
NAVIGATOR	P59E > Select zones						
SMS*	P[MasterCode]E P[InstallerCode]E P59E [Zone Number] E						

* SMS programming and operation requires the optional 106-985 4G Module

Option No.	Description	Default	
P60E	1E	Entry Beeps	ON
	2E	Keyswitch Home/Disarm	OFF
	3E	Keyswitch Arm/Disarm	OFF
	4E	Tamper Siren lockout	ON
	5E	Duress to RESET output	OFF
	6E	Auto Exclude zones	ON
	7E	Auto keypad display off	OFF
	8E	Delayed Aux3, Aux4 outputs	OFF

P60E 1E

ENTRY BEEPS

PROGRAM MODE LEVEL

Installer

FACTORY DEFAULT

Entry Beeps ON.

RELATED OPTIONS

P69E 7E Arm Exit Beeps.
P69E 8E Home Exit Beeps.

The sonalert will beep during Entry Delay.

KPX+	P60E 1E to enable/disable the option
NAVIGATOR	P60E > enable/disable option 1E
SMS*	P[MasterCode]E P[InstallerCode]E P60E 1E

P60E 2E, 3E

KEYSWITCH OPERATION

PROGRAM MODE LEVEL

Installer

FACTORY DEFAULT

Keyswitch disabled.

NOTES

The keyswitch:

- a/ Always Arms Area1 only.
- b/ Does not arm Area2.
- c/ Can disarm Area2 if option P120E 8E is enabled.

- Use a 2K2 resistor on the keyswitch input regardless of the global EOL resistor value set by P129E. Also see P129E, page 59.
- Short the resistor to arm and disarm. Open circuit to trigger Panic alarm.

RELATED OPTIONS

P120E 1E Latched Keyswitch.
P120E 4E Keyswitch Disarms only.
P120E 5E Keyswitch Arms only.
P120E 8E Keyswitch disarm Area2.
P129E EOL Resistor value

An externally fitted, normally open momentary Keyswitch can be used to Arm, Disarm or arm the Home mode.

The keyswitch is wired to zone 8 (zone 8 is then no longer available as a normal alarm input, but is still available for use as a Radio Zone).

2E & 3E OFF: No keyswitch operation. Zone 8 is a normal alarm input.

2E ON: Keyswitch cycles between Home and Disarm.

3E ON: Keyswitch cycles between Arm and Disarm.

2E & 3E ON: Keyswitch cycles between Arm, Home and Disarm.

KPX+	P60E enable/disable 2E 3E as required
NAVIGATOR	P60E > enable/disable 2E 3E as required
SMS*	P[MasterCode]E P[InstallerCode]E P60E 2E 3E as required

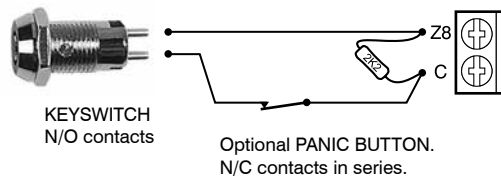
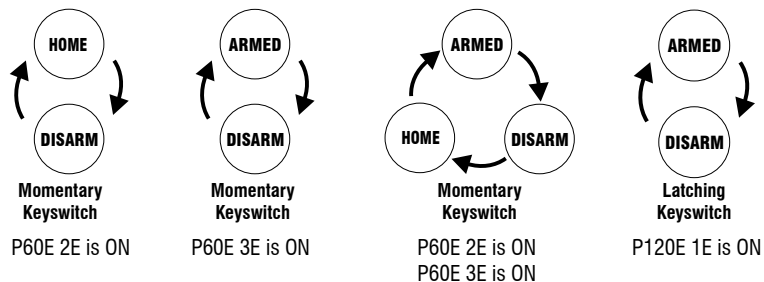

KEYSWITCH WIRING.

A momentary or latching keyswitch can be wired as shown.

Always use a 2K2 resistor regardless of the global EOL resistor value set by P129E

* SMS programming and operation requires the optional 106-985 4G Module

PROGRAMMING

P60E 4E	TAMPER SIREN LOCKOUT						
<p>PROGRAM MODE LEVEL Installer</p> <p>FACTORY DEFAULT ON Tamper Reset Lockout enabled.</p> <p>RELATED OPTIONS P44E Lockout zones.</p>	<p>This option programs the Tamper input to Lockout, i.e. cause the Siren & Reset outputs to sound only once while the panel is armed.</p> <table border="1"> <tr> <td style="background-color: #FF00FF;">KPX+</td> <td>P60E 4E to enable/disable the option</td> </tr> <tr> <td style="background-color: #00FF00;">NAVIGATOR</td> <td>P60E > enable/disable 4E</td> </tr> <tr> <td style="background-color: #00BFFF;">SMS*</td> <td>P[MasterCode]E P[InstallerCode]E P60E 4E</td> </tr> </table>	KPX+	P60E 4E to enable/disable the option	NAVIGATOR	P60E > enable/disable 4E	SMS*	P[MasterCode]E P[InstallerCode]E P60E 4E
KPX+	P60E 4E to enable/disable the option						
NAVIGATOR	P60E > enable/disable 4E						
SMS*	P[MasterCode]E P[InstallerCode]E P60E 4E						
P60E 5E	DURESS TO RESET OUTPUT						
<p>PROGRAM MODE LEVEL Installer</p> <p>FACTORY DEFAULT OFF No Reset output on Duress alarm.</p> <p>RELATED OPTIONS P75E 1E Enable reporting of Duress.</p>	<p>Keypad Duress is normally a silent alarm. This option makes the Duress alarm trigger the Reset output. To Disarm with Duress, add any of the digits 5,6,8 or 9 in front of the user code when Disarming.</p> <table border="1"> <tr> <td style="background-color: #FF00FF;">KPX+</td> <td>P60E 5E to enable/disable the option</td> </tr> <tr> <td style="background-color: #00FF00;">NAVIGATOR</td> <td>P60E > enable/disable 5E</td> </tr> <tr> <td style="background-color: #00BFFF;">SMS*</td> <td>P[MasterCode]E P[InstallerCode]E P60E 5E</td> </tr> </table>	KPX+	P60E 5E to enable/disable the option	NAVIGATOR	P60E > enable/disable 5E	SMS*	P[MasterCode]E P[InstallerCode]E P60E 5E
KPX+	P60E 5E to enable/disable the option						
NAVIGATOR	P60E > enable/disable 5E						
SMS*	P[MasterCode]E P[InstallerCode]E P60E 5E						
P60E 6E	AUTO EXCLUDE ZONES						
<p>PROGRAM MODE LEVEL Installer</p> <p>FACTORY DEFAULT ON Auto Exclude enabled.</p> <p>RELATED OPTIONS P62E 7E Siren burst on Auto Exclude.</p>	<p>If a zone is unsealed at the end of Exit Time the panel can either Exclude (ignore) that zone or immediately alarm.</p> <p>The panel will give a 2 second Siren burst at the end of Exit Time to indicate that the panel is armed with a zone/s Auto Excluded. The 2 sec Siren burst can be disabled by option P62E 7E.</p> <table border="1"> <tr> <td style="background-color: #FF00FF;">KPX+</td> <td>P60E 6E to enable/disable the option</td> </tr> <tr> <td style="background-color: #00FF00;">NAVIGATOR</td> <td>P60E > enable/disable 6E</td> </tr> <tr> <td style="background-color: #00BFFF;">SMS*</td> <td>P[MasterCode]E P[InstallerCode]E P60E 6E</td> </tr> </table>	KPX+	P60E 6E to enable/disable the option	NAVIGATOR	P60E > enable/disable 6E	SMS*	P[MasterCode]E P[InstallerCode]E P60E 6E
KPX+	P60E 6E to enable/disable the option						
NAVIGATOR	P60E > enable/disable 6E						
SMS*	P[MasterCode]E P[InstallerCode]E P60E 6E						
P60E 7E	DISABLE KEYPAD DISPLAY						
<p>PROGRAM MODE LEVEL Installer</p> <p>FACTORY DEFAULT OFF: Display is always ON.</p> <p>NOTES</p> <ul style="list-style-type: none"> • LCD KEYPADS: The LCD display and keys backlighting will turn off. • NAVIGATOR KEYPAD: The touch screen display will go blank. Touch to restore. 	<p>Keypad displays can be programmed to blank after 4 minutes of no keypad use. Any action that causes a beep will restore the display. (LCD keypads, use the (E) button preferably. Navigator Touch Screen Keypad, touch to restore the display).</p> <table border="1"> <tr> <td style="background-color: #FF00FF;">KPX+</td> <td>P60E 7E to enable/disable the option</td> </tr> <tr> <td style="background-color: #00FF00;">NAVIGATOR</td> <td>P60E > enable/disable 7E</td> </tr> <tr> <td style="background-color: #00BFFF;">SMS*</td> <td>P[MasterCode]E P[InstallerCode]E P60E 7E</td> </tr> </table>	KPX+	P60E 7E to enable/disable the option	NAVIGATOR	P60E > enable/disable 7E	SMS*	P[MasterCode]E P[InstallerCode]E P60E 7E
KPX+	P60E 7E to enable/disable the option						
NAVIGATOR	P60E > enable/disable 7E						
SMS*	P[MasterCode]E P[InstallerCode]E P60E 7E						
P60E 8E	DELAYED AUX3 & AUX4 OUTPUTS						
<p>PROGRAM MODE LEVEL Installer</p> <p>FACTORY DEFAULT OFF: AUX3 & AUX4 outputs are instant.</p> <p>RELATED OPTIONS P143E 1E, AUX3 on when Area1 arms. P143E 2E, AUX3 on when Area2 arms. P144E 1E, AUX4 on when Area1 arms. P144E 2E, AUX4 on when Area2 arms.</p>	<p>The AUX3 and AUX4 outputs can be programmed to turn on when Areas 1 and 2 are armed. These outputs can be programmed to turn on instantly or at the end of Exit Time.</p> <p>This option only applies when AUX3 and AUX4 outputs are enabled as Arm1 and Arm2 outputs, (P143E 1E on and P144E 1E on).</p> <table border="1"> <tr> <td style="background-color: #FF00FF;">KPX+</td> <td>P60E 8E to enable/disable the option</td> </tr> <tr> <td style="background-color: #00FF00;">NAVIGATOR</td> <td>P60E > enable/disable 8E</td> </tr> <tr> <td style="background-color: #00BFFF;">SMS*</td> <td>P[MasterCode]E P[InstallerCode]E P60E 8E</td> </tr> </table>	KPX+	P60E 8E to enable/disable the option	NAVIGATOR	P60E > enable/disable 8E	SMS*	P[MasterCode]E P[InstallerCode]E P60E 8E
KPX+	P60E 8E to enable/disable the option						
NAVIGATOR	P60E > enable/disable 8E						
SMS*	P[MasterCode]E P[InstallerCode]E P60E 8E						

* SMS programming and operation requires the optional 106-985 4G Module

Option No.	Description	Default	
P61E	1E	Tamper to RESET output	ON
	2E	Tamper to STROBE output	ON
	3E	Tamper to Keypad Sonalert	ON
	4E	Tamper to SIREN output	ON
	5E	Keypad Panic to RESET output	ON
	6E	Keypad Panic to STROBE output	ON
	7E	Keypad Panic to Sonalert	ON
	8E	Keypad Panic to SIREN output	ON

P61E 1E-4E	TAMPER ALARM / OUTPUT MAPPING						
<p>PROGRAM MODE LEVEL Installer</p> <p>FACTORY DEFAULT 1E-4E, ON: Tamper alarm triggers all outputs.</p> <p>NOTES</p> <ul style="list-style-type: none"> A Tamper Alarm can be caused by the TAMP input or by removing the J1 PROG/TAMP link on the main board. 	<p>This option selects which outputs will trigger when a Tamper Alarm occurs.</p> <p>1E ON: Tamper Alarm to Reset output 2E ON: Tamper Alarm to Strobe output 3E ON: Tamper Alarm to Keypad Sonalert output 4E ON: Tamper Alarm to Siren output</p> <table border="1"> <tr> <td style="background-color: #FF00FF;">KPX+</td> <td>P61E enable/disable 1E ~ 4E as required</td> </tr> <tr> <td style="background-color: #00FF00;">NAVIGATOR</td> <td>P61E > enable/disable 1E ~ 4E as required</td> </tr> <tr> <td style="background-color: #00BFFF;">SMS*</td> <td>P[MasterCode]E P[InstallerCode]E P61E 1E ~ 4E as required</td> </tr> </table>	KPX+	P61E enable/disable 1E ~ 4E as required	NAVIGATOR	P61E > enable/disable 1E ~ 4E as required	SMS*	P[MasterCode]E P[InstallerCode]E P61E 1E ~ 4E as required
KPX+	P61E enable/disable 1E ~ 4E as required						
NAVIGATOR	P61E > enable/disable 1E ~ 4E as required						
SMS*	P[MasterCode]E P[InstallerCode]E P61E 1E ~ 4E as required						
P61E 5E-8E	KEYPAD PANIC ALARM / OUTPUT MAPPING						
<p>PROGRAM MODE LEVEL Installer</p> <p>FACTORY DEFAULT 5E-8E, ON: Panic alarm triggers all outputs.</p> <p>NOTES</p> <ul style="list-style-type: none"> A Keypad Panic Alarm can be caused by the PANIC keys on the keypad (* E or ** together, depending on Option P126E1E). 	<p>This option selects which outputs will trigger when a Keypad Panic alarm occurs.</p> <p>5E ON: Keypad Panic Alarm to Reset output 6E ON: Keypad Panic Alarm to Strobe output 7E ON: Keypad Panic Alarm to Keypad Sonalert output 8E ON: Keypad Panic Alarm to Siren output</p> <table border="1"> <tr> <td style="background-color: #FF00FF;">KPX+</td> <td>P61E enable/disable 5E ~ 8E as required</td> </tr> <tr> <td style="background-color: #00FF00;">NAVIGATOR</td> <td>P61E > enable/disable 5E ~ 8E as required</td> </tr> <tr> <td style="background-color: #00BFFF;">SMS*</td> <td>P[MasterCode]E P[InstallerCode]E P61E 5E ~ 8E as required</td> </tr> </table>	KPX+	P61E enable/disable 5E ~ 8E as required	NAVIGATOR	P61E > enable/disable 5E ~ 8E as required	SMS*	P[MasterCode]E P[InstallerCode]E P61E 5E ~ 8E as required
KPX+	P61E enable/disable 5E ~ 8E as required						
NAVIGATOR	P61E > enable/disable 5E ~ 8E as required						
SMS*	P[MasterCode]E P[InstallerCode]E P61E 5E ~ 8E as required						

* SMS programming and operation requires the optional 106-985 4G Module

PROGRAMMING

Option No.	Description	Default	
P62E	1E	Shortcut Memory display	ON
	2E	Shortcut Zone Exclude	ON
	3E	Shortcut Home Mode	ON
	4E	Shortcut Keypad Panic	OFF
	5E	Shortcut Area1 Arming	ON
	6E	Shortcut Area2 Arming	OFF
	7E	Brief warning on Auto Exclude	ON
	8E	Exit Time x10	OFF

P62E 1E-6E	SYSTEM OPERATION SHORTCUTS						
<p>PROGRAM MODE LEVEL Installer</p> <p>FACTORY DEFAULT 1E ON: Memory Display shortcut enabled 2E ON: Zone Exclude shortcut enabled 3E ON: Home Mode shortcut enabled 4E OFF: Keypad Panic shortcut disabled 5E ON: Area1 Arming shortcut enabled 6E OFF: Area2 Arming shortcut disabled</p> <p>NOTES If either Area1 or Area2 are armed by shortcut and no user codes are assigned to that Area then it will always remain armed. You will then need to enter program mode on power-up and assign codes to Areas.</p> <p>RELATED OPTIONS P126E 1E, 2E, 3E double key keypad functions</p>	<p>Some keypad operations can be programmed to operate with or without a User Code.</p> <p>1E ON: Memory Display shortcut 2E ON: Zone Exclude shortcut 3E ON: Home Mode shortcut 4E ON: Keypad Panic shortcut 5E ON: Area1 Arming shortcut 6E ON: Area2 Arming shortcut</p> <table border="1"> <tr> <td style="background-color: #FF00FF;">KPX+</td> <td>P62E enable/disable 1E ~ 6E as required</td> </tr> <tr> <td style="background-color: #00FF00;">NAVIGATOR</td> <td>P62E > enable/disable 1E ~ 6E as required</td> </tr> <tr> <td style="background-color: #00BFFF;">SMS*</td> <td>P[MasterCode]E P[InstallerCode]E P62E 1E ~ 6E as required</td> </tr> </table> <p>OPERATING EXAMPLES: KPX+ & NAVIGATOR Arming without shortcut: ARM [User Code] E KPX+ & NAVIGATOR Arming with shortcut: ARM E KPX+ Keypad Panic without shortcut: * [User Code] E NAVIGATOR Keypad Panic without shortcut: EMERGENCY > PANIC > [User Code] E KPX+ Keypad Panic with shortcut: * E NAVIGATOR Keypad Panic with shortcut: EMERGENCY > PANIC</p>	KPX+	P62E enable/disable 1E ~ 6E as required	NAVIGATOR	P62E > enable/disable 1E ~ 6E as required	SMS*	P[MasterCode]E P[InstallerCode]E P62E 1E ~ 6E as required
KPX+	P62E enable/disable 1E ~ 6E as required						
NAVIGATOR	P62E > enable/disable 1E ~ 6E as required						
SMS*	P[MasterCode]E P[InstallerCode]E P62E 1E ~ 6E as required						
<p>P62E 7E</p> <p>PROGRAM MODE LEVEL Installer</p> <p>FACTORY DEFAULT ON: Siren burst on Auto Exclude enabled.</p> <p>RELATED OPTIONS P60E 6E Auto Exclude zones.</p>	<p>SIREN BURST ON AUTO EXCLUDE</p> <p>This option allows the disabling of the 2 second siren burst at the end of Exit Time which indicates a zone/s has been Auto Excluded.</p> <table border="1"> <tr> <td style="background-color: #FF00FF;">KPX+</td> <td>P62E 7E to enable/disable the option</td> </tr> <tr> <td style="background-color: #00FF00;">NAVIGATOR</td> <td>P62E > enable/disable 7E</td> </tr> <tr> <td style="background-color: #00BFFF;">SMS*</td> <td>P[MasterCode]E P[InstallerCode]E P62E 7E</td> </tr> </table>	KPX+	P62E 7E to enable/disable the option	NAVIGATOR	P62E > enable/disable 7E	SMS*	P[MasterCode]E P[InstallerCode]E P62E 7E
KPX+	P62E 7E to enable/disable the option						
NAVIGATOR	P62E > enable/disable 7E						
SMS*	P[MasterCode]E P[InstallerCode]E P62E 7E						
<p>P62E 8E</p> <p>PROGRAM MODE LEVEL Installer</p> <p>FACTORY DEFAULT OFF: Exit Time x10 disabled.</p> <p>RELATED OPTIONS P28E Exit Time.</p>	<p>EXIT TIME X10</p> <p>This option multiplies the normal exit time by a factor of 10.</p> <table border="1"> <tr> <td style="background-color: #FF00FF;">KPX+</td> <td>P62E 8E to enable/disable the option</td> </tr> <tr> <td style="background-color: #00FF00;">NAVIGATOR</td> <td>P62E > enable/disable 8E</td> </tr> <tr> <td style="background-color: #00BFFF;">SMS*</td> <td>P[MasterCode]E P[InstallerCode]E P62E 8E</td> </tr> </table>	KPX+	P62E 8E to enable/disable the option	NAVIGATOR	P62E > enable/disable 8E	SMS*	P[MasterCode]E P[InstallerCode]E P62E 8E
KPX+	P62E 8E to enable/disable the option						
NAVIGATOR	P62E > enable/disable 8E						
SMS*	P[MasterCode]E P[InstallerCode]E P62E 8E						

* SMS programming and operation requires the optional 106-985 4G Module

Option No.	Description	Default	
P63E	1E	Home Mode alarms to RESET output	ON
	2E	Home Mode alarms to STROBE	ON
	3E	Home Mode alarms to SONALERT	ON
	4E	Home Mode alarms to SIREN	OFF
	5E	Day Mode to RESET output	OFF
	6E	Day Mode to STROBE	OFF
	7E	Day Mode to keypad SONALERT	ON
	8E	Day Mode to SIREN	OFF

P63E 1E–4E	HOME MODE OUTPUT MAPPING						
<p>PROGRAM MODE LEVEL Installer</p> <p>FACTORY DEFAULT 1E, 2E, 3E ON. 4E OFF.</p> <p>RELATED OPTIONS P64E 1E Brief Home alarm.</p>	<p>This option selects which outputs are triggered by alarms in Home Mode.</p> <p>1E ON: Home Mode to Reset output 2E ON: Home Mode to Strobe output 3E ON: Home Mode to Keypad Sonalert output 4E ON: Home Mode to Siren output</p> <table border="1" style="width: 100%; border-collapse: collapse;"> <tr> <td style="background-color: #FF00FF; color: white; text-align: center;">KPX+</td> <td>P63E enable/disable 1E ~ 4E as required</td> </tr> <tr> <td style="background-color: #00FF00; color: white; text-align: center;">NAVIGATOR</td> <td>P63E > enable/disable 1E ~ 4E as required</td> </tr> <tr> <td style="background-color: #0000FF; color: white; text-align: center;">SMS*</td> <td>P[MasterCode]E P[InstallerCode]E P63E 1E ~ 4E as required</td> </tr> </table>	KPX+	P63E enable/disable 1E ~ 4E as required	NAVIGATOR	P63E > enable/disable 1E ~ 4E as required	SMS*	P[MasterCode]E P[InstallerCode]E P63E 1E ~ 4E as required
KPX+	P63E enable/disable 1E ~ 4E as required						
NAVIGATOR	P63E > enable/disable 1E ~ 4E as required						
SMS*	P[MasterCode]E P[InstallerCode]E P63E 1E ~ 4E as required						
P63E 5E–8E	DAY MODE OUTPUT MAPPING						
<p>PROGRAM MODE LEVEL Installer</p> <p>FACTORY DEFAULT 7E ON. 5E, 6E, 8E OFF</p> <p>RELATED OPTIONS P64E 2E Brief Day alarm.</p> <p>For ZONE TO OUTPUT MAPPING for Armed & 24hr states – see options P54E – P59E, pages 27-28</p>	<p>This option selects which outputs are triggered by alarms in Day Mode.</p> <p>5E ON: Day Mode to Reset output 6E ON: Day Mode to Strobe output, (If Brief Day Alarm is enabled, (P64E 2E), then this option sends day alarms to the AUX2 output). 7E ON: Day Mode to Keypad Sonalert output 8E ON: Day Mode to Siren output</p> <table border="1" style="width: 100%; border-collapse: collapse;"> <tr> <td style="background-color: #FF00FF; color: white; text-align: center;">KPX+</td> <td>P63E enable/disable 5E ~ 8E as required</td> </tr> <tr> <td style="background-color: #00FF00; color: white; text-align: center;">NAVIGATOR</td> <td>P63E > enable/disable 5E ~ 8E as required</td> </tr> <tr> <td style="background-color: #0000FF; color: white; text-align: center;">SMS*</td> <td>P[MasterCode]E P[InstallerCode]E P63E 5E ~ 8E as required</td> </tr> </table>	KPX+	P63E enable/disable 5E ~ 8E as required	NAVIGATOR	P63E > enable/disable 5E ~ 8E as required	SMS*	P[MasterCode]E P[InstallerCode]E P63E 5E ~ 8E as required
KPX+	P63E enable/disable 5E ~ 8E as required						
NAVIGATOR	P63E > enable/disable 5E ~ 8E as required						
SMS*	P[MasterCode]E P[InstallerCode]E P63E 5E ~ 8E as required						

Option No.	Description	Default	
P64E	1E	Brief Home Alarm	OFF
	2E	Brief Day Alarm	OFF
	3E	Home zones Entry Delay2	ON
	4E	Radio Key SIREN CHIRPS	OFF
	5E	[not used]	OFF
	6E	Strobe Flash on Home arm by radio	OFF
	7E	[not used]	OFF
	8E	[not used]	OFF

P64E 1E	BRIEF HOME MODE ALARM						
<p>PROGRAM MODE LEVEL Installer</p> <p>FACTORY DEFAULT OFF: Brief Home Alarm disabled.</p> <p>RELATED OPTIONS P51E Set Home zones. P63E 1E–4E Home Mode output mapping</p>	<p>Alarms in Home Mode can either activate the programmed outputs for Siren Time duration (P29E) or they can activate the outputs for 2 seconds only.</p> <p>NOTE: If Brief Home alarm is enabled, then Home alarms will not be reported by communicator.</p> <table border="1" style="width: 100%; border-collapse: collapse;"> <tr> <td style="background-color: #FF00FF; color: white; text-align: center;">KPX+</td> <td>P64E 1E to enable/disable the option</td> </tr> <tr> <td style="background-color: #00FF00; color: white; text-align: center;">NAVIGATOR</td> <td>P64E > enable/disable 1E</td> </tr> <tr> <td style="background-color: #0000FF; color: white; text-align: center;">SMS*</td> <td>P[MasterCode]E P[InstallerCode]E P64E 1E</td> </tr> </table>	KPX+	P64E 1E to enable/disable the option	NAVIGATOR	P64E > enable/disable 1E	SMS*	P[MasterCode]E P[InstallerCode]E P64E 1E
KPX+	P64E 1E to enable/disable the option						
NAVIGATOR	P64E > enable/disable 1E						
SMS*	P[MasterCode]E P[InstallerCode]E P64E 1E						

* SMS programming and operation requires the optional 106-985 4G Module

PROGRAMMING

P64E 2E	BRIEF DAY ALARM & ENABLE TEMPORARY DAY ZONES						
<p>PROGRAM MODE LEVEL Installer</p> <p>FACTORY DEFAULT OFF: Brief Day Alarm disabled.</p> <p>RELATED OPTIONS P53E Assign Day zones. P63E 5E–8E Day Mode output mapping.</p>	<p>Alarms in Day Mode will activate the programmed outputs while the zone is unsealed or they can activate the outputs for 2 seconds only.</p> <p>This option also enables the TEMPORARY DAY ZONE feature. See page 25.</p> <table border="1" style="width: 100%;"> <tr> <td style="background-color: #FF00FF; color: white; text-align: center;">KPX+</td> <td>P64E 2E to enable/disable the option</td> </tr> <tr> <td style="background-color: #00FF00; color: white; text-align: center;">NAVIGATOR</td> <td>P64E > enable/disable 2E</td> </tr> <tr> <td style="background-color: #00BFFF; color: white; text-align: center;">SMS*</td> <td>P[MasterCode]E P[InstallerCode]E P64E 2E</td> </tr> </table>	KPX+	P64E 2E to enable/disable the option	NAVIGATOR	P64E > enable/disable 2E	SMS*	P[MasterCode]E P[InstallerCode]E P64E 2E
KPX+	P64E 2E to enable/disable the option						
NAVIGATOR	P64E > enable/disable 2E						
SMS*	P[MasterCode]E P[InstallerCode]E P64E 2E						
P64E 3E	HOME ZONES ENTRY DELAY 2						
<p>PROGRAM MODE LEVEL Installer</p> <p>FACTORY DEFAULT ON: Home zones all have Entry Delay2.</p> <p>RELATED OPTIONS P27E Entry Delay Time 2. P51E Assign Home zones. P63E 1E–4E Home Mode output mapping.</p>	<p>Home zones can either have the delay types set by options P40E–P43E or they can all be assigned to have Entry Delay 2. This allows all Home zones to be programmed with the same entry delay time.</p> <table border="1" style="width: 100%;"> <tr> <td style="background-color: #FF00FF; color: white; text-align: center;">KPX+</td> <td>P64E 3E to enable/disable the option</td> </tr> <tr> <td style="background-color: #00FF00; color: white; text-align: center;">NAVIGATOR</td> <td>P64E > enable/disable 3E</td> </tr> <tr> <td style="background-color: #00BFFF; color: white; text-align: center;">SMS*</td> <td>P[MasterCode]E P[InstallerCode]E P64E 3E</td> </tr> </table>	KPX+	P64E 3E to enable/disable the option	NAVIGATOR	P64E > enable/disable 3E	SMS*	P[MasterCode]E P[InstallerCode]E P64E 3E
KPX+	P64E 3E to enable/disable the option						
NAVIGATOR	P64E > enable/disable 3E						
SMS*	P[MasterCode]E P[InstallerCode]E P64E 3E						
P64E 4E	ARM/DISARM CHIRPS						
<p>PROGRAM MODE LEVEL Installer</p> <p>FACTORY DEFAULT OFF: No siren chirps.</p> <p>RELATED OPTIONS P68E 8E Quiet Chirps. P69E 5E Home Arm by Radio Key. P120E 2E Home Arm chirps. P120E 3E Radio Key AUX button arms Home Mode.</p>	<p>If this option is selected the Siren output will "Chirp" when the panel is armed and disarmed with the Keyswitch input, prox cards or Radio Keys. This option applies to <i>siren chirps</i>, the <i>strobe</i> output always flashes when arming/disarming by the above methods. (Home arming chirps are enabled separately by option P120E 2E).</p> <p>The siren output will make 1 Chirp on Arming, and 3 Chirps on Disarming.</p> <table border="1" style="width: 100%;"> <tr> <td style="background-color: #FF00FF; color: white; text-align: center;">KPX+</td> <td>P64E 4E to enable/disable the option</td> </tr> <tr> <td style="background-color: #00FF00; color: white; text-align: center;">NAVIGATOR</td> <td>P64E > enable/disable 4E</td> </tr> <tr> <td style="background-color: #00BFFF; color: white; text-align: center;">SMS*</td> <td>P[MasterCode]E P[InstallerCode]E P64E 4E</td> </tr> </table>	KPX+	P64E 4E to enable/disable the option	NAVIGATOR	P64E > enable/disable 4E	SMS*	P[MasterCode]E P[InstallerCode]E P64E 4E
KPX+	P64E 4E to enable/disable the option						
NAVIGATOR	P64E > enable/disable 4E						
SMS*	P[MasterCode]E P[InstallerCode]E P64E 4E						
P64E 6E	STROBE FLASH ON HOME ARMING BY RADIO						
<p>PROGRAM MODE LEVEL Installer</p> <p>FACTORY DEFAULT OFF: No strobe.</p> <p>NOTES This is not related to strobe flash on arming and disarming area 1 or 2 by radio key, which always flashes the strobe on arm and disarm.</p> <p>RELATED OPTIONS P69E 5E Home Mode arming by radio key. P120E 2E Siren Chirp on Home Arming by Radio</p>	<p>This option enables a brief strobe flash when arming Home Mode by radio key or radio keypad. This applies to Home Mode arming only, disarming Home Mode by radio key never flashes the strobe.</p> <table border="1" style="width: 100%;"> <tr> <td style="background-color: #FF00FF; color: white; text-align: center;">KPX+</td> <td>P64E 6E to enable/disable the option</td> </tr> <tr> <td style="background-color: #00FF00; color: white; text-align: center;">NAVIGATOR</td> <td>P64E > enable/disable 6E</td> </tr> <tr> <td style="background-color: #00BFFF; color: white; text-align: center;">SMS*</td> <td>P[MasterCode]E P[InstallerCode]E P64E 6E</td> </tr> </table>	KPX+	P64E 6E to enable/disable the option	NAVIGATOR	P64E > enable/disable 6E	SMS*	P[MasterCode]E P[InstallerCode]E P64E 6E
KPX+	P64E 6E to enable/disable the option						
NAVIGATOR	P64E > enable/disable 6E						
SMS*	P[MasterCode]E P[InstallerCode]E P64E 6E						

* SMS programming and operation requires the optional 106-985 4G Module

Option No.	Description	ZONES 1-8								ZONES 9-32 IF FITTED							
		1	2	3	4	5	6	7	8	9	10	11	31	31	32
P65E	SUPERVISED ZONES																

P65E	SUPERVISED ZONES						
<p>PROGRAM MODE LEVEL Installer</p> <p>FACTORY DEFAULT all OFF: No Supervision zones.</p> <p>NOTES If Radio Supervision is enabled, P66E 5E off, then the supervision feature cannot be used as an inactivity monitor.</p> <p>RELATED OPTIONS P66E 1E-4E Supervision Alerts. P66E 5E Wired Zone Supervision. P67E Zone Supervision Time. P75E 12E Report Supervision.</p> <div style="border: 1px solid #ccc; padding: 5px; margin-top: 10px;"> <p>KPX+ PRO TIP</p> <p>When selecting zones, MEMORY E selects all zones, 0 E deselects all zones</p> </div>	<p>Any zone 1-8 or zones 9-32, with optional exander/s fitted, can be a Supervised Zone.</p> <p>Supervision for HARDWIRED ZONES</p> <p>In operation, a Supervised Zone is subject to the Supervision Time (P67E). If the zone/s has not sealed or unsealed during the Supervision Time, then the programmed alerts will turn on (as programmed by P66E 1E-4E, P92E 4E or P75E 12E). Zone Supervision can be used as an "inactivity monitor" to sound an alert or send a comms report if a zone has had no activity during a set period of time. (For example, to monitor an aged person's home).</p> <ul style="list-style-type: none"> • A zone which is permanently in a sealed or unsealed state for the duration of Supervision Time will be treated as a Supervision alarm. • If P66E 5E is on, Zone Supervision acts on wired zones. If P66E 5E is off, Zone Supervision acts on radio zones. • Each Supervised zone has its own supervision timer. • Zone Supervision is independent of the armed state of the panel. • Zone Supervision can be temporarily disabled by Excluding the zone/s. • The zone which caused the Supervision alarm flashes on the keypad. Entering a valid code + E will reset Supervision alarms. <p>Supervision for RADIO ZONES</p> <p>The purpose of Radio Supervision is to verify the correct operation of Ness Radio PIRs. The Supervision signal from the Radio PIR tells the panel that the device has not been removed from radio range and is in working order.</p> <p>A non-SUPERVISION enabled Radio PIR will transmit signals to the panel only when it has detected an event. Obviously, there is no guaranteed signal period.</p> <p>In either case, when the allowed time limit is exceeded then a WARNING is first given (if programmed by P66E 3E), and then after 1 minute, the programmed RADIO SUPERVISION ALERTS are generated by the panel.</p> <p>P66E 5E must be off for supervision to work on radio zones.</p> <table border="1" style="width: 100%; border-collapse: collapse;"> <tr> <td style="background-color: #FF00FF; color: white; padding: 2px;">KPX+</td> <td>P65E [Zone Number] E to enable/disable zones</td> </tr> <tr> <td style="background-color: #00FF00; color: white; padding: 2px;">NAVIGATOR</td> <td>P65E > Select zones</td> </tr> <tr> <td style="background-color: #00FFFF; color: white; padding: 2px;">SMS*</td> <td>P[MasterCode]E P[InstallerCode]E P65E [Zone Number] E</td> </tr> </table>	KPX+	P65E [Zone Number] E to enable/disable zones	NAVIGATOR	P65E > Select zones	SMS*	P[MasterCode]E P[InstallerCode]E P65E [Zone Number] E
KPX+	P65E [Zone Number] E to enable/disable zones						
NAVIGATOR	P65E > Select zones						
SMS*	P[MasterCode]E P[InstallerCode]E P65E [Zone Number] E						

RADIO SUPERVISION OPERATION

The purpose of Radio Supervision is to verify the correct operation of Ness Radio PIRs. The Supervision signal from the Radio PIR tells the panel that the device has not been removed from radio range and is in working order.

A non-SUPERVISION enabled Radio PIR will transmit signals to the panel only when it has detected an event. Obviously, there is no guaranteed signal period.

In either case, when the allowed time limit is exceeded then a WARNING is first given (if programmed by P66E 3E), and then after 1 minute, the programmed RADIO SUPERVISION ALERTS are generated by the panel.

* SMS programming and operation requires the optional 106-985 4G Module

PROGRAMMING

Option No.	Description	Default	
P66E	1E	Zone Supervision alarm to RESET output	OFF
	2E	Zone Supervision alarm to STROBE	OFF
	3E	Zone Supervision alarm to SONALERT	OFF
	4E	Zone Supervision alarm to SIREN	OFF
	5E	Enable WIRED ZONE supervision	OFF
	6E		OFF
	7E	Zone Supervision speedup x 6	OFF
	8E	Zone Supervision speedup x10	OFF

P66E 1E	ZONE SUPERVISION ALERTS – RESET OUTPUT						
<p>PROGRAM MODE LEVEL Installer</p> <p>FACTORY DEFAULT OFF: Supervision Reset output disabled.</p> <p>RELATED OPTIONS P65E Supervised Zones.</p>	<p>Setting this option turns the Reset output ON when a SUPERVISED ZONE alert occurs. The Reset output will remain ON for the duration of the ALARM TIME (Set by Option P29E).</p> <table border="1"> <tr> <td style="background-color: #FF00FF; color: white;">KPX+</td> <td>P66E 1E to enable/disable the option</td> </tr> <tr> <td style="background-color: #00FF00; color: white;">NAVIGATOR</td> <td>P66E > enable/disable 1E</td> </tr> <tr> <td style="background-color: #00BFFF; color: white;">SMS*</td> <td>P[MasterCode]E P[InstallerCode]E P66E 1E</td> </tr> </table>	KPX+	P66E 1E to enable/disable the option	NAVIGATOR	P66E > enable/disable 1E	SMS*	P[MasterCode]E P[InstallerCode]E P66E 1E
KPX+	P66E 1E to enable/disable the option						
NAVIGATOR	P66E > enable/disable 1E						
SMS*	P[MasterCode]E P[InstallerCode]E P66E 1E						
P66E 2E	ZONE SUPERVISION ALERTS – STROBE OUTPUT						
<p>PROGRAM MODE LEVEL Installer</p> <p>FACTORY DEFAULT OFF: Supervision Strobe output disabled.</p> <p>RELATED OPTIONS P65E Supervised Zones.</p>	<p>Setting this option turns the Strobe output ON when a SUPERVISED ZONE alert occurs. The Strobe output will remain ON until the panel is disarmed.</p> <table border="1"> <tr> <td style="background-color: #FF00FF; color: white;">KPX+</td> <td>P66E 2E to enable/disable the option</td> </tr> <tr> <td style="background-color: #00FF00; color: white;">NAVIGATOR</td> <td>P66E > enable/disable 2E</td> </tr> <tr> <td style="background-color: #00BFFF; color: white;">SMS*</td> <td>P[MasterCode]E P[InstallerCode]E P66E 2E</td> </tr> </table>	KPX+	P66E 2E to enable/disable the option	NAVIGATOR	P66E > enable/disable 2E	SMS*	P[MasterCode]E P[InstallerCode]E P66E 2E
KPX+	P66E 2E to enable/disable the option						
NAVIGATOR	P66E > enable/disable 2E						
SMS*	P[MasterCode]E P[InstallerCode]E P66E 2E						
P66E 3E	ZONE SUPERVISION ALERTS – KEYPAD SONALERT						
<p>PROGRAM MODE LEVEL Installer</p> <p>FACTORY DEFAULT OFF: Supervision Keypad Sonalert disabled.</p> <p>NOTES When this option is turned ON, it delays the operation of all other selected Supervision outputs by one minute.</p> <p>RELATED OPTIONS P65E Supervised Zones.</p>	<p>Setting this option turns the Keypad Sonalert ON when a SUPERVISED ZONE alert occurs. The Keypad Sonalert remains ON until <i>any</i> keypad key is pressed.</p> <p>Also, turning this option ON makes all Supervision outputs delayed by one minute.</p> <table border="1"> <tr> <td style="background-color: #FF00FF; color: white;">KPX+</td> <td>P66E 3E to enable/disable the option</td> </tr> <tr> <td style="background-color: #00FF00; color: white;">NAVIGATOR</td> <td>P66E > enable/disable 3E</td> </tr> <tr> <td style="background-color: #00BFFF; color: white;">SMS*</td> <td>P[MasterCode]E P[InstallerCode]E P66E 3E</td> </tr> </table>	KPX+	P66E 3E to enable/disable the option	NAVIGATOR	P66E > enable/disable 3E	SMS*	P[MasterCode]E P[InstallerCode]E P66E 3E
KPX+	P66E 3E to enable/disable the option						
NAVIGATOR	P66E > enable/disable 3E						
SMS*	P[MasterCode]E P[InstallerCode]E P66E 3E						
P66E 4E	ZONE SUPERVISION ALERTS – SIREN OUTPUT						
<p>PROGRAM MODE LEVEL Installer</p> <p>FACTORY DEFAULT OFF: Supervision Siren output disabled.</p> <p>RELATED OPTIONS P65E Supervised Zones.</p>	<p>Setting this option turns the Siren output ON when a SUPERVISED ZONE alert occurs. The Siren output will remain ON for the duration of the ALARM TIME (Set by Option P29E).</p> <table border="1"> <tr> <td style="background-color: #FF00FF; color: white;">KPX+</td> <td>P66E 4E to enable/disable the option</td> </tr> <tr> <td style="background-color: #00FF00; color: white;">NAVIGATOR</td> <td>P66E > enable/disable 4E</td> </tr> <tr> <td style="background-color: #00BFFF; color: white;">SMS*</td> <td>P[MasterCode]E P[InstallerCode]E P66E 4E</td> </tr> </table>	KPX+	P66E 4E to enable/disable the option	NAVIGATOR	P66E > enable/disable 4E	SMS*	P[MasterCode]E P[InstallerCode]E P66E 4E
KPX+	P66E 4E to enable/disable the option						
NAVIGATOR	P66E > enable/disable 4E						
SMS*	P[MasterCode]E P[InstallerCode]E P66E 4E						

* SMS programming and operation requires the optional 106-985 4G Module

P66E 5E	ENABLE WIRED ZONE SUPERVISION						
<p>PROGRAM MODE LEVEL Installer</p> <p>FACTORY DEFAULT OFF: Radio Zone Supervision enabled.</p> <p>RELATED OPTIONS P65E Supervised Zones. P66E 1E–4E Supervision Alerts. P66E 5E Wired Zone Supervision. P67E Zone Supervision Time. P75E 12E Report Zone Supervision.</p>	<p>This option enables Wired Zone Supervision or Radio Zone Supervision.</p> <p>Option OFF: Radio Zone Supervision is enabled</p> <p>Option ON: Wired Zone Supervision is enabled</p> <table border="1"> <tr> <td style="background-color: #FF00FF; color: white;">KPX+</td> <td>P66E 5E to enable/disable the option</td> </tr> <tr> <td style="background-color: #00FF00; color: white;">NAVIGATOR</td> <td>P66E > enable/disable 5E</td> </tr> <tr> <td style="background-color: #00BFFF; color: white;">SMS*</td> <td>P[MasterCode]E P[InstallerCode]E P66E 5E</td> </tr> </table>	KPX+	P66E 5E to enable/disable the option	NAVIGATOR	P66E > enable/disable 5E	SMS*	P[MasterCode]E P[InstallerCode]E P66E 5E
KPX+	P66E 5E to enable/disable the option						
NAVIGATOR	P66E > enable/disable 5E						
SMS*	P[MasterCode]E P[InstallerCode]E P66E 5E						
P66E 7E	SUPERVISION TIME SPEEDUP X6						
<p>PROGRAM MODE LEVEL Installer</p> <p>FACTORY DEFAULT OFF: Supervision Time normal.</p> <p>RELATED OPTIONS P67E Supervision Time. P66E 8E Supervision Time speedup x10.</p>	<p>Enable this this option to speed up the Supervision Time by 6. For instance if P67E is set to 1 hour (60 minutes), then this option will reduce it to 10 minutes. (i.e., 60 divided by 6).</p> <table border="1"> <tr> <td style="background-color: #FF00FF; color: white;">KPX+</td> <td>P66E 7E to enable/disable the option</td> </tr> <tr> <td style="background-color: #00FF00; color: white;">NAVIGATOR</td> <td>P66E > enable/disable 7E</td> </tr> <tr> <td style="background-color: #00BFFF; color: white;">SMS*</td> <td>P[MasterCode]E P[InstallerCode]E P66E 7E</td> </tr> </table>	KPX+	P66E 7E to enable/disable the option	NAVIGATOR	P66E > enable/disable 7E	SMS*	P[MasterCode]E P[InstallerCode]E P66E 7E
KPX+	P66E 7E to enable/disable the option						
NAVIGATOR	P66E > enable/disable 7E						
SMS*	P[MasterCode]E P[InstallerCode]E P66E 7E						
P66E 8E	SUPERVISION TIME SPEEDUP X10						
<p>PROGRAM MODE LEVEL Installer</p> <p>FACTORY DEFAULT OFF: Supervision Time normal.</p> <p>RELATED OPTIONS P67E Supervision Time. P66E 7E Supervision Time speedup x6.</p>	<p>Enable this option to speed up the Supervision Time by 10. For instance if P67E is set to 1 hour (60 minutes), then this option will reduce it to 6 minutes. (i.e., 60 divided by 10).</p> <table border="1"> <tr> <td style="background-color: #FF00FF; color: white;">KPX+</td> <td>P66E 8E to enable/disable the option</td> </tr> <tr> <td style="background-color: #00FF00; color: white;">NAVIGATOR</td> <td>P66E > enable/disable 8E</td> </tr> <tr> <td style="background-color: #00BFFF; color: white;">SMS*</td> <td>P[MasterCode]E P[InstallerCode]E P66E 8E</td> </tr> </table>	KPX+	P66E 8E to enable/disable the option	NAVIGATOR	P66E > enable/disable 8E	SMS*	P[MasterCode]E P[InstallerCode]E P66E 8E
KPX+	P66E 8E to enable/disable the option						
NAVIGATOR	P66E > enable/disable 8E						
SMS*	P[MasterCode]E P[InstallerCode]E P66E 8E						



NOTE: If P66E 7E and 8E are both ON then the Supervision time is sped up by 60. For instance if P67E is set to 1 hour (60 minutes), then this option will reduce it to 1 minute. (i.e., 60 divided by 60).

P67E	SUPERVISION TIME						
<p>PROGRAM MODE LEVEL User, Installer</p> <p>FACTORY DEFAULT 24 hours or 24 minutes.</p> <p>NOTES</p> <ul style="list-style-type: none"> Supervision time for wired or wireless zones must be 2 minutes or greater for correct operation. A setting of less than 3 hours for radio supervision is not recommended. The Supervision timer is reset on exit from Installer Program Mode and on Arm or Disarm. <p>RELATED OPTIONS P65E Supervised Zones. P66E 1E–4E Supervision Alerts. P66E 7E–8E Supervision Time Speed-up.</p>	<p>SUPERVISION TIME sets the time interval before an inactive Supervised Zone triggers a Supervision alarm.</p> <p>The SUPERVISION TIME setting is from 01 to 24 hours.</p> <p>For timing up to 24 minutes, set P66E 7E & 8E on.</p> <p>For timing up to 24 hours, set P66E 7E & 8E off.</p> <table border="1"> <tr> <td style="background-color: #FF00FF; color: white;">KPX+</td> <td>P67E [New Time] E</td> </tr> <tr> <td style="background-color: #00FF00; color: white;">NAVIGATOR</td> <td>P67E > Enter new time</td> </tr> <tr> <td style="background-color: #00BFFF; color: white;">SMS*</td> <td>P[MasterCode]E P67E [NewTime]E</td> </tr> </table>	KPX+	P67E [New Time] E	NAVIGATOR	P67E > Enter new time	SMS*	P[MasterCode]E P67E [NewTime]E
KPX+	P67E [New Time] E						
NAVIGATOR	P67E > Enter new time						
SMS*	P[MasterCode]E P67E [NewTime]E						

* SMS programming and operation requires the optional 106-985 4G Module

PROGRAMMING

Option No.	Description	Default	
P68E	1E	Double Press Radio Panic	OFF
	2E	Auto Re-Arm	OFF
	3E	Long Radio Message	ON
	4E	"OK/READY" Display	OFF
	5E	Radio Arming "unsealed" warning	OFF
	6E	24hr Zone Fire Siren sound	OFF
	7E	Single Shot strobe on Arm by R/Key	OFF
	8E	Quiet chirps on radio Arm/Disarm	OFF

P68E 1E	DOUBLE PRESS RADIO PANIC						
<p>PROGRAM MODE LEVEL Installer</p> <p>FACTORY DEFAULT OFF: Single Press Radio Panic.</p>	<p>Setting this option ON enables Double Press Panic for Ness Radio Keys, if fitted. The panel will look for two radio Panic signals in a row to sound the Panic alarm.</p> <p>OPERATION. On the Radio Key, press and hold Panic until the transmit LED turns on. Wait until the LED turns off then release the Panic button and immediately press and hold again until the transmit LED turns on a second time.</p> <p>This requirement meets regulations in some states of Australia.</p> <table border="1" style="width: 100%;"> <tr> <td style="background-color: #FF00FF; color: white;">KPX+</td> <td>P68E 1E to enable/disable the option</td> </tr> <tr> <td style="background-color: #00FF00; color: white;">NAVIGATOR</td> <td>P68E > enable/disable 1E</td> </tr> <tr> <td style="background-color: #00BFFF; color: white;">SMS*</td> <td>P[MasterCode]E P[InstallerCode]E P68E 1E</td> </tr> </table>	KPX+	P68E 1E to enable/disable the option	NAVIGATOR	P68E > enable/disable 1E	SMS*	P[MasterCode]E P[InstallerCode]E P68E 1E
KPX+	P68E 1E to enable/disable the option						
NAVIGATOR	P68E > enable/disable 1E						
SMS*	P[MasterCode]E P[InstallerCode]E P68E 1E						
P68E 2E	AUTO RE-ARM						
<p>PROGRAM MODE LEVEL Installer</p> <p>FACTORY DEFAULT OFF: Auto Re-Arm disabled.</p> <p>NOTES</p> <ul style="list-style-type: none"> • Auto re-arm will not take place if the panel is disarmed during the exit delay time. This allows you to disarm immediately if you change your mind about leaving the premises. • Auto re-arm operates independently on both Areas 1 and 2. <p>RELATED OPTIONS P26E Entry Delay Time1 sets the "time before re-arming". For example, say P26E is 30sec, if you disarm the panel and do not enter the premises, then the panel will Auto Re-arm in 30 seconds.</p>	<p>When this option is enabled, Auto Re-Arm checks that you have entered the premises after disarming.</p> <p>After disarming, the panel will wait for the duration set for Entry Delay. If all zones remain sealed the panel will re-arm. This is most useful when used with radio keys where the OFF button might be accidentally pressed after you have armed and are leaving the premises.</p> <table border="1" style="width: 100%;"> <tr> <td style="background-color: #FF00FF; color: white;">KPX+</td> <td>P68E 2E to enable/disable the option</td> </tr> <tr> <td style="background-color: #00FF00; color: white;">NAVIGATOR</td> <td>P68E > enable/disable 2E</td> </tr> <tr> <td style="background-color: #00BFFF; color: white;">SMS*</td> <td>P[MasterCode]E P[InstallerCode]E P68E 2E</td> </tr> </table>	KPX+	P68E 2E to enable/disable the option	NAVIGATOR	P68E > enable/disable 2E	SMS*	P[MasterCode]E P[InstallerCode]E P68E 2E
KPX+	P68E 2E to enable/disable the option						
NAVIGATOR	P68E > enable/disable 2E						
SMS*	P[MasterCode]E P[InstallerCode]E P68E 2E						
P68E 3E	LONG RADIO MESSAGE						
<p>PROGRAM MODE LEVEL Installer</p> <p>FACTORY DEFAULT ON: Long Radio Message.</p> <p>NOTES Some models of Ness detectors and radio keys without encryption will not work with this setting on.</p> <p>If a radio device is not recognised when you try to enrol it on this control panel, turn this option off then attempt to enrol the radio device.</p>	<p>Setting this option ON enables Long Radio Message for Radio Keys and Radio Devices. Radio detectors will now need the encryption link turned on. Enabling Long Radio Message gives greater protection against coding clashes with third party radio signals.</p> <table border="1" style="width: 100%;"> <tr> <td style="background-color: #FF00FF; color: white;">KPX+</td> <td>P68E 3E to enable/disable the option</td> </tr> <tr> <td style="background-color: #00FF00; color: white;">NAVIGATOR</td> <td>P68E > enable/disable 3E</td> </tr> <tr> <td style="background-color: #00BFFF; color: white;">SMS*</td> <td>P[MasterCode]E P[InstallerCode]E P68E 3E</td> </tr> </table>	KPX+	P68E 3E to enable/disable the option	NAVIGATOR	P68E > enable/disable 3E	SMS*	P[MasterCode]E P[InstallerCode]E P68E 3E
KPX+	P68E 3E to enable/disable the option						
NAVIGATOR	P68E > enable/disable 3E						
SMS*	P[MasterCode]E P[InstallerCode]E P68E 3E						

* SMS programming and operation requires the optional 106-985 4G Module

P68E 4E	"OK/READY" DISPLAY OPTION						
<p>PROGRAM MODE LEVEL Installer</p> <p>FACTORY DEFAULT OFF: OK/READY ignores delay zones.</p>	<p>When the option is OFF, the OK/READY icon will display even if Entry Delay zones are unsealed. This is useful in cases where the keypad location is covered by a PIR with entry delay.</p> <p>When this option is ON, all zones including Entry Delay zones must be sealed for the keypad/s to display the OK/READY icon.</p> <table border="1" style="width: 100%;"> <tr> <td style="background-color: #FF00FF; color: white;">KPX+</td> <td>P68E 4E to enable/disable the option</td> </tr> <tr> <td style="background-color: #00FF00; color: white;">NAVIGATOR</td> <td>P68E > enable/disable 4E</td> </tr> <tr> <td style="background-color: #00BFFF; color: white;">SMS*</td> <td>P[MasterCode]E P[InstallerCode]E P68E 4E</td> </tr> </table>	KPX+	P68E 4E to enable/disable the option	NAVIGATOR	P68E > enable/disable 4E	SMS*	P[MasterCode]E P[InstallerCode]E P68E 4E
KPX+	P68E 4E to enable/disable the option						
NAVIGATOR	P68E > enable/disable 4E						
SMS*	P[MasterCode]E P[InstallerCode]E P68E 4E						
P68E 5E	RADIO KEY ARMING, UNSEALED ZONE WARNING						
<p>PROGRAM MODE LEVEL Installer</p> <p>FACTORY DEFAULT OFF: Radio Key siren warning disabled.</p>	<p>Setting this option ON allows a 2 second SIREN warning if there is an unsealed zone in an Area Armed by a Radio Key.</p> <table border="1" style="width: 100%;"> <tr> <td style="background-color: #FF00FF; color: white;">KPX+</td> <td>P68E 5E to enable/disable the option</td> </tr> <tr> <td style="background-color: #00FF00; color: white;">NAVIGATOR</td> <td>P68E > enable/disable 5E</td> </tr> <tr> <td style="background-color: #00BFFF; color: white;">SMS*</td> <td>P[MasterCode]E P[InstallerCode]E P68E 5E</td> </tr> </table>	KPX+	P68E 5E to enable/disable the option	NAVIGATOR	P68E > enable/disable 5E	SMS*	P[MasterCode]E P[InstallerCode]E P68E 5E
KPX+	P68E 5E to enable/disable the option						
NAVIGATOR	P68E > enable/disable 5E						
SMS*	P[MasterCode]E P[InstallerCode]E P68E 5E						
P68E 6E	24HR ZONE FIRE SIREN SOUND						
<p>PROGRAM MODE LEVEL Installer</p> <p>FACTORY DEFAULT OFF: No 24hr Fire siren sound.</p>	<p>This option changes the siren sound when a 24hr zone is triggered. The keypad key sequence for FIRE (3 E) always outputs the FIRE siren sound.</p> <table border="1" style="width: 100%;"> <tr> <td style="background-color: #FF00FF; color: white;">KPX+</td> <td>P68E 6E to enable/disable the option</td> </tr> <tr> <td style="background-color: #00FF00; color: white;">NAVIGATOR</td> <td>P68E > enable/disable 6E</td> </tr> <tr> <td style="background-color: #00BFFF; color: white;">SMS*</td> <td>P[MasterCode]E P[InstallerCode]E P68E 6E</td> </tr> </table>	KPX+	P68E 6E to enable/disable the option	NAVIGATOR	P68E > enable/disable 6E	SMS*	P[MasterCode]E P[InstallerCode]E P68E 6E
KPX+	P68E 6E to enable/disable the option						
NAVIGATOR	P68E > enable/disable 6E						
SMS*	P[MasterCode]E P[InstallerCode]E P68E 6E						
P68E 7E	SINGLE SHOT STROBE ON ARMING						
<p>PROGRAM MODE LEVEL Installer</p> <p>FACTORY DEFAULT OFF: Strobe Flash on very ARM signal.</p>	<p>This option provides a choice of operation for the strobe flash when arming by a Radio Key. When this option is OFF the strobe will flash every time an ARM signal is received from a valid Radio Key. If the panel is armed any subsequent ARM signals will flash the strobe light. The panel will not change state because it already armed.</p> <p>When this option is ON the strobe will flash only when the panel arms. Any subsequent ARM signals will be ignored.</p> <table border="1" style="width: 100%;"> <tr> <td style="background-color: #FF00FF; color: white;">KPX+</td> <td>P68E 7E to enable/disable the option</td> </tr> <tr> <td style="background-color: #00FF00; color: white;">NAVIGATOR</td> <td>P68E > enable/disable 7E</td> </tr> <tr> <td style="background-color: #00BFFF; color: white;">SMS*</td> <td>P[MasterCode]E P[InstallerCode]E P68E 7E</td> </tr> </table>	KPX+	P68E 7E to enable/disable the option	NAVIGATOR	P68E > enable/disable 7E	SMS*	P[MasterCode]E P[InstallerCode]E P68E 7E
KPX+	P68E 7E to enable/disable the option						
NAVIGATOR	P68E > enable/disable 7E						
SMS*	P[MasterCode]E P[InstallerCode]E P68E 7E						
P68E 8E	QUIET CHIRPS ON ARM/DISARM						
<p>PROGRAM MODE LEVEL Installer</p> <p>FACTORY DEFAULT OFF: Quiet Chirps disabled.</p> <p>RELATED OPTIONS P64E 4E Radio Key Chirps. P69E 5E Home Arm by Radio Key. P120E 2E Home Arm chirps. P120E 3E Radio Key AUX / arms Home Mode P162E Chirp Siren Volume</p>	<p>This quietyens the siren chirps that are made whenever keyswitch or radio key Arming or Disarming is used. (Arm/Disarm Chirps must be enabled at P64E 4E).</p> <table border="1" style="width: 100%;"> <tr> <td style="background-color: #FF00FF; color: white;">KPX+</td> <td>P68E 8E to enable/disable the option</td> </tr> <tr> <td style="background-color: #00FF00; color: white;">NAVIGATOR</td> <td>P68E > enable/disable 8E</td> </tr> <tr> <td style="background-color: #00BFFF; color: white;">SMS*</td> <td>P[MasterCode]E P[InstallerCode]E P68E 8E</td> </tr> </table>	KPX+	P68E 8E to enable/disable the option	NAVIGATOR	P68E > enable/disable 8E	SMS*	P[MasterCode]E P[InstallerCode]E P68E 8E
KPX+	P68E 8E to enable/disable the option						
NAVIGATOR	P68E > enable/disable 8E						
SMS*	P[MasterCode]E P[InstallerCode]E P68E 8E						

* SMS programming and operation requires the optional 106-985 4G Module

PROGRAMMING

Option No.	Description	Default	
P69E	1E	Flash strobe on medical alert	OFF
	2E	[not used]	OFF
	3E	Quiet Home Siren	OFF
	4E	6 beeps on Arming	OFF
	5E	Home arm by radio key ON/OFF	OFF
	6E	Disable Mains Fail Alarm	OFF
	7E	Exit BEEPS - Full Arm	OFF
	8E	Exit BEEPS - Home Mode	OFF

P69E 1E	FLASH STROBE ON MEDICAL ALARM						
<p>PROGRAM MODE LEVEL Installer</p> <p>FACTORY DEFAULT OFF</p>	<p>This option enables the strobe output when a medical alarm is triggered. This is to make the house visible to the ambulance. The strobe will reset after 72 hours or when a valid code is entered.</p> <table border="1" style="width: 100%;"> <tr> <td style="background-color: #FF00FF; color: white;">KPX+</td> <td>P69E 1E to enable/disable the option</td> </tr> <tr> <td style="background-color: #00FF00; color: white;">NAVIGATOR</td> <td>P69E > enable/disable 1E</td> </tr> <tr> <td style="background-color: #00BFFF; color: white;">SMS*</td> <td>P[MasterCode]E P[InstallerCode]E P69E 1E</td> </tr> </table>	KPX+	P69E 1E to enable/disable the option	NAVIGATOR	P69E > enable/disable 1E	SMS*	P[MasterCode]E P[InstallerCode]E P69E 1E
KPX+	P69E 1E to enable/disable the option						
NAVIGATOR	P69E > enable/disable 1E						
SMS*	P[MasterCode]E P[InstallerCode]E P69E 1E						
P69E 3E	QUIET HOME SIREN						
<p>PROGRAM MODE LEVEL Installer</p> <p>FACTORY DEFAULT OFF: Normal siren sound in Home Mode.</p> <p>NOTES This does not affect the RESET output.</p>	<p>This option selects the 'Quiet Siren' sound in Home Mode. The Quiet Siren sound is a continuous "beep beep beep" sound rather than the normal siren sound.</p> <table border="1" style="width: 100%;"> <tr> <td style="background-color: #FF00FF; color: white;">KPX+</td> <td>P69E 3E to enable/disable the option</td> </tr> <tr> <td style="background-color: #00FF00; color: white;">NAVIGATOR</td> <td>P69E > enable/disable 3E</td> </tr> <tr> <td style="background-color: #00BFFF; color: white;">SMS*</td> <td>P[MasterCode]E P[InstallerCode]E P69E 3E</td> </tr> </table>	KPX+	P69E 3E to enable/disable the option	NAVIGATOR	P69E > enable/disable 3E	SMS*	P[MasterCode]E P[InstallerCode]E P69E 3E
KPX+	P69E 3E to enable/disable the option						
NAVIGATOR	P69E > enable/disable 3E						
SMS*	P[MasterCode]E P[InstallerCode]E P69E 3E						
P69E 4E	6 BEEPS ON ARMING						
<p>PROGRAM MODE LEVEL Installer</p> <p>FACTORY DEFAULT OFF: Keypad gives 3 beeps on Arming.</p> <p>NOTES The keypad beeps on Arm/Disarm when Arming/Disarming by keypad, keyswitch or by Radio Key.</p>	<p>Normally the keypad/s onboard sonalert/beeper gives 3 beeps when the panel is armed. Turning this option ON will give 6 keypad beeps when Arming.</p> <table border="1" style="width: 100%;"> <tr> <td style="background-color: #FF00FF; color: white;">KPX+</td> <td>P69E 4E to enable/disable the option</td> </tr> <tr> <td style="background-color: #00FF00; color: white;">NAVIGATOR</td> <td>P69E > enable/disable 4E</td> </tr> <tr> <td style="background-color: #00BFFF; color: white;">SMS*</td> <td>P[MasterCode]E P[InstallerCode]E P69E 4E</td> </tr> </table>	KPX+	P69E 4E to enable/disable the option	NAVIGATOR	P69E > enable/disable 4E	SMS*	P[MasterCode]E P[InstallerCode]E P69E 4E
KPX+	P69E 4E to enable/disable the option						
NAVIGATOR	P69E > enable/disable 4E						
SMS*	P[MasterCode]E P[InstallerCode]E P69E 4E						
P69E 5E	HOME ARMING BY RADIO KEY ON/OFF BUTTONS						
<p>PROGRAM MODE LEVEL Installer</p> <p>FACTORY DEFAULT OFF</p> <p>NOTES</p> <ul style="list-style-type: none"> Radio Key Home Arming will work only if one or more zones have been programmed as Home Zones (P51E). <p>RELATED OPTIONS</p> <p>P51E Program Home zones. P64E 1E Brief Home alarm. P64E 6E Strobe Flash on Home arm by radio key P69E 3E Quiet Home siren P69E 5E Home Arm by Radio Key P120E 2E Home arm chirps by Radio Key P120E 3E Radio Key AUX arms Home P120E 6E Smart Beeps</p>	<p>Setting this option on allows Home Mode arming by Radio Key ON or OFF buttons. Note: This is independent of Home arming by AUX button if using the RK4 radio key.</p> <p>Operation:</p> <ul style="list-style-type: none"> - Press the Radio Key OFF button twice within 4 seconds. or.... - Press the Radio Key ON button twice within 5 seconds. <p>See page 25 for Home operation.</p> <table border="1" style="width: 100%;"> <tr> <td style="background-color: #FF00FF; color: white;">KPX+</td> <td>P69E 5E to enable/disable the option</td> </tr> <tr> <td style="background-color: #00FF00; color: white;">NAVIGATOR</td> <td>P69E > enable/disable 5E</td> </tr> <tr> <td style="background-color: #00BFFF; color: white;">SMS*</td> <td>P[MasterCode]E P[InstallerCode]E P69E 5E</td> </tr> </table>	KPX+	P69E 5E to enable/disable the option	NAVIGATOR	P69E > enable/disable 5E	SMS*	P[MasterCode]E P[InstallerCode]E P69E 5E
KPX+	P69E 5E to enable/disable the option						
NAVIGATOR	P69E > enable/disable 5E						
SMS*	P[MasterCode]E P[InstallerCode]E P69E 5E						

* SMS programming and operation requires the optional 106-985 4G Module

P69E 6E	DISABLE MAINS FAIL ALARM						
<p>PROGRAM MODE LEVEL Installer</p> <p>FACTORY DEFAULT OFF: Mains Fail alarm normal.</p> <p>NOTES This does not affect mains fail reporting or saving to the History memory or operation of the Mains Fail output on the Output Expander. Does not apply to Navigator keypad.</p>	<p>When set ON, a Mains Fail alarm is: a) Not displayed on the keypad b) Does not give warning beeps c) Is not saved to MEMORY and the MEMORY display does not flash.</p> <table border="1"> <tr> <td style="background-color: #FF00FF;">KPX+</td> <td>P69E 6E to enable/disable the option</td> </tr> <tr> <td style="background-color: #00FF00;">NAVIGATOR</td> <td>P69E > enable/disable 6E</td> </tr> <tr> <td style="background-color: #00BFFF;">SMS*</td> <td>P[MasterCode]E P[InstallerCode]E P69E 6E</td> </tr> </table>	KPX+	P69E 6E to enable/disable the option	NAVIGATOR	P69E > enable/disable 6E	SMS*	P[MasterCode]E P[InstallerCode]E P69E 6E
KPX+	P69E 6E to enable/disable the option						
NAVIGATOR	P69E > enable/disable 6E						
SMS*	P[MasterCode]E P[InstallerCode]E P69E 6E						
P69E 7E	BEEPS DURING EXIT DELAY - FULLY ARMED MODE						
<p>PROGRAM MODE LEVEL Installer</p> <p>FACTORY DEFAULT Exit Beeps OFF.</p> <p>RELATED OPTIONS P28E Exit Delay Time.</p>	<p>When set ON, this option gives an audible warning during Exit Delay.</p> <p>The keypad/s will beep slowly during Exit Delay when the panel is in exit delay (armed by any Area). When the Exit Time has 16 to 20 seconds remaining, the beeps will change to faster double-beep for the remainder of the Exit Time. The end of Exit Time is announced by 3 beeps.</p> <table border="1"> <tr> <td style="background-color: #FF00FF;">KPX+</td> <td>P69E 7E to enable/disable the option</td> </tr> <tr> <td style="background-color: #00FF00;">NAVIGATOR</td> <td>P69E > enable/disable 7E</td> </tr> <tr> <td style="background-color: #00BFFF;">SMS*</td> <td>P[MasterCode]E P[InstallerCode]E P69E 7E</td> </tr> </table>	KPX+	P69E 7E to enable/disable the option	NAVIGATOR	P69E > enable/disable 7E	SMS*	P[MasterCode]E P[InstallerCode]E P69E 7E
KPX+	P69E 7E to enable/disable the option						
NAVIGATOR	P69E > enable/disable 7E						
SMS*	P[MasterCode]E P[InstallerCode]E P69E 7E						
P69E 8E	BEEPS DURING EXIT DELAY - HOME MODE						
<p>PROGRAM MODE LEVEL Installer</p> <p>FACTORY DEFAULT Home Exit Beeps OFF.</p> <p>RELATED OPTIONS P28E Exit Delay Time</p> <p>NOTES 1. Exit beeps cannot be stopped (i.e. by pressing a key on the keypad). 2. If another event causes a different keypad beep, the exit beeps resume once the event beeps are finished.</p>	<p>When set ON, This option gives an audible warning during Home Mode Exit Delay.</p> <p>The sonalert will give a fast double-beep during Exit Delay when the panel is in Home Mode Exit Delay. The end of Exit Time is announced by 3 beeps.</p> <table border="1"> <tr> <td style="background-color: #FF00FF;">KPX+</td> <td>P69E 8E to enable/disable the option</td> </tr> <tr> <td style="background-color: #00FF00;">NAVIGATOR</td> <td>P69E > enable/disable 8E</td> </tr> <tr> <td style="background-color: #00BFFF;">SMS*</td> <td>P[MasterCode]E P[InstallerCode]E P69E 8E</td> </tr> </table>	KPX+	P69E 8E to enable/disable the option	NAVIGATOR	P69E > enable/disable 8E	SMS*	P[MasterCode]E P[InstallerCode]E P69E 8E
KPX+	P69E 8E to enable/disable the option						
NAVIGATOR	P69E > enable/disable 8E						
SMS*	P[MasterCode]E P[InstallerCode]E P69E 8E						

Option No.	Description	ZONES 1-8								ZONES 9-32 IF FITTED							
		1	2	3	4	5	6	7	8	9	10	11	31	31	32
P94E	NO MEMORY WARNING ZONES																

P94E	NO MEMORY WARNING ZONES						
<p>PROGRAM MODE LEVEL Installer</p> <p>FACTORY DEFAULT no zones selected.</p> <p>KPX+ PRO TIP When selecting zones, MEMORY E selects all, 0 E deselects all.</p>	<p>Select zones that do not flash the Memory indicator on the keypad/s. Alarm events on those zones are still stored in memory and can be reviewed as normal.</p> <table border="1"> <tr> <td style="background-color: #FF00FF;">KPX+</td> <td>P94E [Zone Number] E to enable/disable zones</td> </tr> <tr> <td style="background-color: #00FF00;">NAVIGATOR</td> <td>P94E > Select zones</td> </tr> <tr> <td style="background-color: #00BFFF;">SMS*</td> <td>P[MasterCode]E P[InstallerCode]E P94E [Zone Number] E</td> </tr> </table>	KPX+	P94E [Zone Number] E to enable/disable zones	NAVIGATOR	P94E > Select zones	SMS*	P[MasterCode]E P[InstallerCode]E P94E [Zone Number] E
KPX+	P94E [Zone Number] E to enable/disable zones						
NAVIGATOR	P94E > Select zones						
SMS*	P[MasterCode]E P[InstallerCode]E P94E [Zone Number] E						

* SMS programming and operation requires the optional 106-985 4G Module

PROGRAMMING

RESTORE FACTORY DEFAULTS

Option No. Description

Option No.	Description
P95E	CLEAR RADIO DEVICES
P96E	CLEAR MEMORY
P97E	CLEAR PANEL OPTIONS (RESTORE FACTORY DEFAULTS)
P98E	CLEAR USER CODES
P99E	PROGRAM INSTALLER CODE

P95E

CLEAR RADIO DEVICES

PROGRAM MODE LEVEL

Installer

FACTORY DEFAULT

[not applicable]

This option clears all Radio Devices assigned to zones.
(This option does not clear User Codes).

KPX+	P95E to delete radio device codes
NAVIGATOR	P95E > to delete radio device codes
SMS*	P[MasterCode]E P[InstallerCode]E P95E

P96E

CLEAR MEMORY

PROGRAM MODE LEVEL

Installer

FACTORY DEFAULT

[not applicable]

This option clears events in the Alarm Memory display.

Note: This option clears only the 20 event memory as read by KPX+ and Saturn keypads. Ness Navigator touch screen keypad's 80 event memory is not affected.

KPX+	P96E to clear alarm memory
NAVIGATOR	P96E > to clear alarm memory
SMS*	P[MasterCode]E P[InstallerCode]E P96E

P97E

CLEAR PANEL OPTIONS

PROGRAM MODE LEVEL

Installer

FACTORY DEFAULT

[not applicable]

NOTES

Note, this option will also delete Radio Devices programmed on zones.

This option restores all panel program options to their factory default values.

Defaults all program options except User Codes and Radio Codes.

Note, this option will also delete Radio Devices programmed on zones.

KPX+	P97E to restore factory defaults
NAVIGATOR	P97E > to restore factory defaults
SMS*	P[MasterCode]E P[InstallerCode]E P97E

P98E

CLEAR USER CODES

PROGRAM MODE LEVEL

Installer

FACTORY DEFAULT

User Code 1: 123

All other codes: [blank]

NOTES

This option DOES NOT clear the Installer Code.

This option defaults all User Codes, (all Keypad Codes, Radio Keys and Access cards) and restores User Code 1 to the factory setting of 123.

P201E – P256E are defaulted (User Codes 1–56)

KPX+	P98E to default user codes
NAVIGATOR	P97E > to default user codes
SMS*	P[MasterCode]E P[InstallerCode]E P98E

P99E

PROGRAM THE INSTALLER CODE

PROGRAM MODE LEVEL

Installer

FACTORY DEFAULT

000000

Programs the installer code. This code can be 3 to 6 digits long. Factory default installer code is 000000.

KPX+	P99E [New Installer Code] E [New Installer Code] E
NAVIGATOR	P99E > [New Installer Code] E [New Installer Code] E
SMS*	P[MasterCode]E P[InstallerCode]E P99E [New Installer Code] E

For a complete list of factory default values, see the Programming Options Summary on pages 73-78.

Option No.	Description	Default
P117E 1E	Enable Output Expander	OFF
2E	Expander Output Format A, B	OFF
3E	Day Zone follower	OFF
4E	Output Exclude	OFF
5E	Expander Output Format C, D	OFF
6E	User Code Toggle or Pulse	OFF

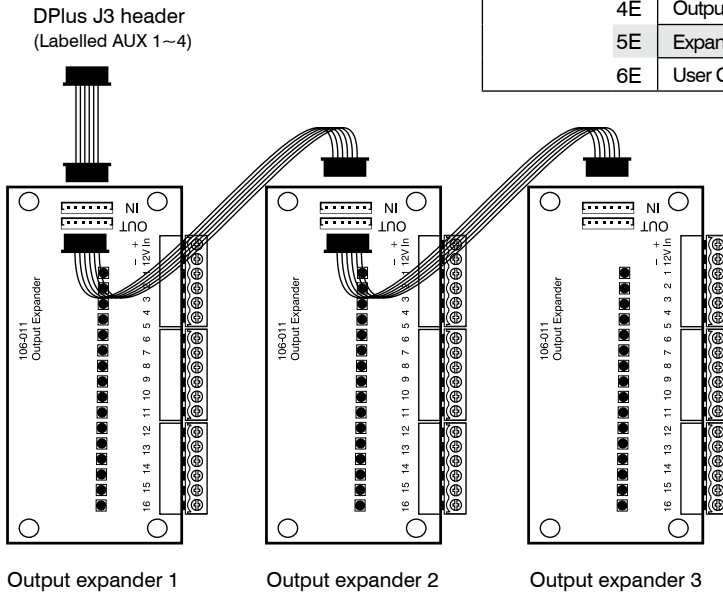

OPTIONAL 106-011 OUTPUT EXPANDERS (MAX. 3)

P117E	OUTPUT EXPANDER OPTIONS 1E - 6E						
PROGRAM MODE LEVEL Installer FACTORY DEFAULT Refer to table.	Enable or disable P117E 1E to 8E as required. <table border="1" style="margin-top: 10px;"> <tr> <td style="background-color: #ff00ff; color: white;">KPX+</td> <td>P117E 1E - 8E to enable/disable options as required</td> </tr> <tr> <td style="background-color: #00ff00; color: white;">NAVIGATOR</td> <td>P117E > enable/disable 1E - 8E as required</td> </tr> <tr> <td style="background-color: #00bfff; color: white;">SMS*</td> <td>P[MasterCode]E P[InstallerCode]E P117E [1E - 8E] as required</td> </tr> </table>	KPX+	P117E 1E - 8E to enable/disable options as required	NAVIGATOR	P117E > enable/disable 1E - 8E as required	SMS*	P[MasterCode]E P[InstallerCode]E P117E [1E - 8E] as required
KPX+	P117E 1E - 8E to enable/disable options as required						
NAVIGATOR	P117E > enable/disable 1E - 8E as required						
SMS*	P[MasterCode]E P[InstallerCode]E P117E [1E - 8E] as required						
P117E 1E	ENABLE OUTPUT EXPANDER						
FACTORY DEFAULT OFF: No Output Expander. NOTES Connect up to three Output Expander boards.	Selecting this option enables the optional 106-011 Output Expander/s (three expanders can be connected as per the diagram on this page). P117E 1E OFF: Connect one optional 106-013 Four Relay Board to AUX P117E 1E ON: Connect up to three optional 106-011 Output Expanders to AUX						
P117E 2E, 5E	EXPANDER FORMAT A, B, C, D						
FACTORY DEFAULT OFF	SEE NEXT PAGE						
P117E 3E	DAY ZONE FOLLOWER						
FACTORY DEFAULT OFF: No Day Zone Follower. NOTES Day zone outputs are turned off when the panel is in Home or Area modes.	When enabled, this option allows Day zones to appear on the Zone Outputs. In Day mode the Zone Output will follow the state of any active Day zone. This occurs independently of the Program Zone selections P118E (Output Expander Zone Follower) and P119E (Output Expander Zone Latch).						
P117E 4E	OUTPUT EXCLUDE						
FACTORY DEFAULT OFF: No Output Exclude.	When enabled, this option allows zones selected for Manual Exclusion (not Auto Exclusion) to also Exclude the Expander Zone outputs. With this option ON, and if a zone has been manually excluded then it will not signal an alarm on the Expander.						
P117E 6E	USER CODE TOGGLE OR PULSE						
FACTORY DEFAULT OFF	When enabled, this option changes User Codes 13, 14 & 15 to PULSE their output on an output expander when operated by a Radio Key AUX button. This allows up to three users to remotely control separate access points such as garage doors. Note that other actions set for the Radio Key AUX button are unchanged.						

PROGRAMMING

P117E 2E, 5E	EXPANDER FORMAT A, B, C, D
FACTORY DEFAULT OFF	Use P117E 2E & 5E in combination to configure the Output Expander/s outputs as per the output format tables. Different combinations of outputs are available for either single, dual or triple output expanders.

		EXPANDER FORMAT			
		A	B	C	D
P117E	2E	OFF	ON	OFF	ON
	5E	OFF	OFF	ON	ON

NOTES

- The first 106-011 Output Expander plugs into the J3 header on the DPlus main board. The second and third expanders plug into the OUT header on the preceding expander. The expander closest to the panel is Expander 1.

- The User Code outputs will follow the ON/OFF state of the User Codes 13 to 15. These outputs can be made to change via:

A) Radio key. Pressing the ON button turns the output On, OFF turns it OFF. A Radio key must be programmed to a User Code 13~15 for this will operate.

B) Radio keypad auxiliary key. The radio keypad auxiliary key (there are 2 auxiliary keys) must be programmed to a User Code 13~15.

C) A DPlus keypad using ARM - DISARM with a User Code. Enter Arm+User_Code_13~15 to turn the output on. User_Code_13~15 + E will turn the output off. Note that the USER CODE does not have to be assigned to an AREA for this to work.

- If P117E 6E is ON then the ARM, DISARM buttons on Radio Keys do not change the Code13-15 outputs on the output expander. Only the AUX button works, pulsing ON the Code13-15 output for the time set by P145E

OUTPUT	Output Format A			Output Format B		
	P117E 1E = ON P117E 2E = OFF P117E 5E = OFF			P117E 1E = ON P117E 2E = ON P117E 5E = OFF		
	EXPANDER 1 (Or if using only one expander)	EXPANDER 2	EXPANDER 3	EXPANDER 1 (Or if using only one expander)	EXPANDER 2	EXPANDER 3
1	Zone 1	Zone 17	Aux 5	Zone 1	Zone 17	Aux 5
2	Zone 2	Zone 18	Aux 6	Zone 2	Zone 18	Aux 6
3	Zone 3	Zone 19	Aux 7	Zone 3	Zone 19	Aux 7
4	Zone 4	Zone 20	Aux 8	Zone 4	Zone 20	Aux 8
5	Zone 5	Zone 21	User Code 13	Zone 5	Zone 21	User Code 13
6	Zone 6	Zone 22	User Code 14	Zone 6	Zone 22	User Code 14
7	Zone 7	Zone 23	User Code 15	Zone 7	Zone 23	User Code 15
8	Zone 8	Zone 24	Comms Fail	Zone 8	Zone 24	Comms Fail
9	Zone 9	Zone 25	Aux 1	Aux 1	Zone 25	Zone 9
10	Zone 10	Zone 26	Aux 2	Aux 2	Zone 26	Zone 10
11	Zone 11	Zone 27	Aux 3	Aux 3	Zone 27	Zone 11
12	Zone 12	Zone 28	Aux 4	Aux 4	Zone 28	Zone 12
13	Zone 13	Zone 29	Arm Home	Arm Home	Zone 29	Zone 13
14	Zone 14	Zone 30	Mains Fail	Mains Fail	Zone 30	Zone 14
15	Zone 15	Zone 31	Battery Fail	Battery Fail	Zone 31	Zone 15
16	Zone 16	Zone 32	Ext. Tamper	Ext. Tamper	Zone 32	Zone 16

OUTPUT	Output Format C			Output Format D		
	P117E 1E = ON P117E 2E = OFF P117E 5E = ON			P117E 1E = ON P117E 2E = ON P117E 5E = ON		
	EXPANDER 1 (Or if using only one expander)	EXPANDER 2	EXPANDER 3	EXPANDER 1 (Or if using only one expander)	EXPANDER 2	EXPANDER 3
1	Aux 5	Zone 1	Zone 17	Zone 1	Aux 5	Zone 17
2	Aux 6	Zone 2	Zone 18	Zone 2	Aux 6	Zone 18
3	Aux 7	Zone 3	Zone 19	Zone 3	Aux 7	Zone 19
4	Aux 8	Zone 4	Zone 20	Zone 4	Aux 8	Zone 20
5	User Code 13	Zone 5	Zone 21	Zone 5	User Code 13	Zone 21
6	User Code 14	Zone 6	Zone 22	Zone 6	User Code 14	Zone 22
7	User Code 15	Zone 7	Zone 23	Zone 7	User Code 15	Zone 23
8	Comms Fail	Zone 8	Zone 24	Zone 8	Comms Fail	Zone 24
9	Aux 1	Zone 9	Zone 25	Aux 1	Zone 9	Zone 25
10	Aux 2	Zone 10	Zone 26	Aux 2	Zone 10	Zone 26
11	Aux 3	Zone 11	Zone 27	Aux 3	Zone 11	Zone 27
12	Aux 4	Zone 12	Zone 28	Aux 4	Zone 12	Zone 28
13	Arm Home	Zone 13	Zone 29	Arm Home	Zone 13	Zone 29
14	Mains Fail	Zone 14	Zone 30	Mains Fail	Zone 14	Zone 30
15	Battery Fail	Zone 15	Zone 31	Battery Fail	Zone 15	Zone 31
16	Ext. Tamper	Zone 16	Zone 32	Ext. Tamper	Zone 16	Zone 32

Option No.	Description	ZONES 1-8								ZONES 9-32 IF FITTED							
		1	2	3	4	5	6	7	8	9	10	11	31	31	32
P118E	OUTPUT EXPANDER ZONES																
P119E	OUTPUT EXPANDER ALARM ZONES																

P118E	OUTPUT EXPANDER ZONES						
<p>PROGRAM MODE LEVEL Installer</p> <p>FACTORY DEFAULT All OFF: No Output Expander zones.</p> <p>NOTES Selecting a zone in both P118E & P119E options effectively gives pulsed outputs whenever that zone alarms.</p> <p>KPX+ PRO TIP When selecting zones, MEMORY E selects all, 0 E deselects all.</p>	<p>Select zones that will be output whenever the zone is unsealed. When the zone reseals the output automatically goes off.</p> <p>Additionally if a zone is also selected in P119 (to zone latch) then an output will only occur whenever a zone is in alarm and is also unsealed. In this case when the zone reseals the output automatically goes off again. A further zone unseal will turn the zone Expander output On again.</p> <table border="1" style="width: 100%; border-collapse: collapse;"> <tr> <td style="background-color: #ff00ff; color: white; text-align: center;">KPX+</td> <td>P118E [Zone Number] E to enable/disable zones</td> </tr> <tr> <td style="background-color: #00ff00; color: white; text-align: center;">NAVIGATOR</td> <td>P118E > Select zones</td> </tr> <tr> <td style="background-color: #00bfff; color: white; text-align: center;">SMS*</td> <td>P[MasterCode]E P[InstallerCode]E P118E [Zone Number] E</td> </tr> </table>	KPX+	P118E [Zone Number] E to enable/disable zones	NAVIGATOR	P118E > Select zones	SMS*	P[MasterCode]E P[InstallerCode]E P118E [Zone Number] E
KPX+	P118E [Zone Number] E to enable/disable zones						
NAVIGATOR	P118E > Select zones						
SMS*	P[MasterCode]E P[InstallerCode]E P118E [Zone Number] E						
P119E	OUTPUT EXPANDER ALARM ZONES						
<p>PROGRAM MODE LEVEL Installer</p> <p>FACTORY DEFAULT All OFF: No Output Expander Alarm zones.</p> <p>KPX+ PRO TIP When selecting zones, MEMORY E selects all, 0 E deselects all.</p>	<p>This selects the zones that will be output whenever the zone is latched into alarm. The output goes off only when the alarm system is reset.</p> <p>Additionally if a zone is also selected in P118 (to zone follow) then an output will only occur whenever a zone is in alarm and is also unsealed. (See P118 above).</p> <table border="1" style="width: 100%; border-collapse: collapse;"> <tr> <td style="background-color: #ff00ff; color: white; text-align: center;">KPX+</td> <td>P119E [Zone Number] E to enable/disable zones</td> </tr> <tr> <td style="background-color: #00ff00; color: white; text-align: center;">NAVIGATOR</td> <td>P119E > Select zones</td> </tr> <tr> <td style="background-color: #00bfff; color: white; text-align: center;">SMS*</td> <td>P[MasterCode]E P[InstallerCode]E P119E [Zone Number] E</td> </tr> </table>	KPX+	P119E [Zone Number] E to enable/disable zones	NAVIGATOR	P119E > Select zones	SMS*	P[MasterCode]E P[InstallerCode]E P119E [Zone Number] E
KPX+	P119E [Zone Number] E to enable/disable zones						
NAVIGATOR	P119E > Select zones						
SMS*	P[MasterCode]E P[InstallerCode]E P119E [Zone Number] E						

PROGRAMMING

Option No.	Description	Default	
P120E	1E	Latched keyswitch input	OFF
	2E	Siren Chirp on Home Arming by Radio	OFF
	3E	Radio Key AUX arms Home Mode	OFF
	4E	Keyswitch DISARM only	OFF
	5E	Keyswitch ARM only	OFF
	6E	Smart Beep	OFF
	7E	Entry Delay Extender	OFF
	8E	Area2 Disarm by Keyswitch Allowed	OFF

P120E 1E	LATCHED KEYSWITCH						
<p>PROGRAM MODE LEVEL Installer</p> <p>FACTORY DEFAULT OFF</p> <p>RELATED OPTIONS P60E 2E, 3E Keyswitch options.</p>	<p>This option enables the use of a latched, (2 position on/off), keyswitch. Keyswitch operation must first be enabled using options P60E 2E, 3E, page page 29.</p> <p>Note: Enabling Latched keyswitch disables all other methods of arming and disarming (keypad, radio key, card).</p> <table border="1"> <tr> <td style="background-color: #FF00FF;">KPX+</td> <td>P120E 1E to enable/disable the option</td> </tr> <tr> <td style="background-color: #00FF00;">NAVIGATOR</td> <td>P120E > enable/disable 1E</td> </tr> <tr> <td style="background-color: #00BFFF;">SMS*</td> <td>P[MasterCode]E P[InstallerCode]E P120E 1E</td> </tr> </table>	KPX+	P120E 1E to enable/disable the option	NAVIGATOR	P120E > enable/disable 1E	SMS*	P[MasterCode]E P[InstallerCode]E P120E 1E
KPX+	P120E 1E to enable/disable the option						
NAVIGATOR	P120E > enable/disable 1E						
SMS*	P[MasterCode]E P[InstallerCode]E P120E 1E						
P120E 2E	SIREN CHIRP ON HOME ARMING BY RADIO						
<p>PROGRAM MODE LEVEL Installer</p> <p>FACTORY DEFAULT OFF</p> <p>NOTE This option enables Radio Key Home Arming chirps regardless of the state of P64E 4E (Radio Key siren chirps).</p> <p>RELATED OPTIONS P64E 6E Strobe Flash on Home Arming by Radio.</p>	<p>This option enables siren chirps when arming and disarming Home Mode with a Radio Key.</p> <table border="1"> <tr> <td style="background-color: #FF00FF;">KPX+</td> <td>P120E 2E to enable/disable the option</td> </tr> <tr> <td style="background-color: #00FF00;">NAVIGATOR</td> <td>P120E > enable/disable 2E</td> </tr> <tr> <td style="background-color: #00BFFF;">SMS*</td> <td>P[MasterCode]E P[InstallerCode]E P120E 2E</td> </tr> </table>	KPX+	P120E 2E to enable/disable the option	NAVIGATOR	P120E > enable/disable 2E	SMS*	P[MasterCode]E P[InstallerCode]E P120E 2E
KPX+	P120E 2E to enable/disable the option						
NAVIGATOR	P120E > enable/disable 2E						
SMS*	P[MasterCode]E P[InstallerCode]E P120E 2E						
P120E 3E	RADIO AUX BUTTON ARMS HOME MODE						
<p>PROGRAM MODE LEVEL Installer</p> <p>FACTORY DEFAULT OFF</p> <p>NOTE This option also enables Radio Key Home Arming chirps regardless of the state of P64E 4E (Radio Key siren chirps).</p> <p>RELATED OPTIONS P69E 5E Radio key Home arm by ON/OFF buttons.</p>	<p>This option enables the AUX button on a Ness RK4 Radio Key to arm Home Mode. When this option is enabled, options P122E 3E & 4E will be disabled, (AUX button to Aux2 options. See page 50).</p> <p>(This option is independent of P69E 5E, Home arming by radio key ON/OFF buttons).</p> <table border="1"> <tr> <td style="background-color: #FF00FF;">KPX+</td> <td>P120E 3E to enable/disable the option</td> </tr> <tr> <td style="background-color: #00FF00;">NAVIGATOR</td> <td>P120E > enable/disable 3E</td> </tr> <tr> <td style="background-color: #00BFFF;">SMS*</td> <td>P[MasterCode]E P[InstallerCode]E P120E 3E</td> </tr> </table>	KPX+	P120E 3E to enable/disable the option	NAVIGATOR	P120E > enable/disable 3E	SMS*	P[MasterCode]E P[InstallerCode]E P120E 3E
KPX+	P120E 3E to enable/disable the option						
NAVIGATOR	P120E > enable/disable 3E						
SMS*	P[MasterCode]E P[InstallerCode]E P120E 3E						
P120E 4E	KEYSWITCH DISARM ONLY						
<p>PROGRAM MODE LEVEL Installer</p> <p>FACTORY DEFAULT OFF</p> <p>RELATED OPTIONS P120E 1E Latched Keyswitch. P60E 2E, 3E Keyswitch options</p>	<p>Converts the use of keyswitch operation using P60E 2E and 3E to only Disarm either from Area or Home mode. Keyswitch operation must first be enabled using options P60E 2E, 3E.</p> <table border="1"> <tr> <td style="background-color: #FF00FF;">KPX+</td> <td>P120E 4E to enable/disable the option</td> </tr> <tr> <td style="background-color: #00FF00;">NAVIGATOR</td> <td>P120E > enable/disable 4E</td> </tr> <tr> <td style="background-color: #00BFFF;">SMS*</td> <td>P[MasterCode]E P[InstallerCode]E P120E 4E</td> </tr> </table>	KPX+	P120E 4E to enable/disable the option	NAVIGATOR	P120E > enable/disable 4E	SMS*	P[MasterCode]E P[InstallerCode]E P120E 4E
KPX+	P120E 4E to enable/disable the option						
NAVIGATOR	P120E > enable/disable 4E						
SMS*	P[MasterCode]E P[InstallerCode]E P120E 4E						

* SMS programming and operation requires the optional 106-985 4G Module

P120E 5E	KEYSWITCH ARM ONLY						
<p>PROGRAM MODE LEVEL Installer</p> <p>FACTORY DEFAULT OFF</p> <p>RELATED OPTIONS P120E 1E Latched Keypad. P60E 2E, 3E Keypad options</p>	<p>Converts the use of keypad operation using P60E 2E and 3E to only arm either from Area or Home mode. Keypad operation must first be enabled using options P60E 2E, 3E, page 29.</p> <table border="1"> <tr> <td style="background-color: #FF00FF;">KPX+</td> <td>P120E 5E to enable/disable the option</td> </tr> <tr> <td style="background-color: #00FF00;">NAVIGATOR</td> <td>P120E > enable/disable 5E</td> </tr> <tr> <td style="background-color: #00BFFF;">SMS*</td> <td>P[MasterCode]E P[InstallerCode]E P120E 5E</td> </tr> </table>	KPX+	P120E 5E to enable/disable the option	NAVIGATOR	P120E > enable/disable 5E	SMS*	P[MasterCode]E P[InstallerCode]E P120E 5E
KPX+	P120E 5E to enable/disable the option						
NAVIGATOR	P120E > enable/disable 5E						
SMS*	P[MasterCode]E P[InstallerCode]E P120E 5E						
P120E 6E	SMART BEEPS						
<p>PROGRAM MODE LEVEL Installer</p> <p>FACTORY DEFAULT OFF</p> <p>NOTES</p> <ul style="list-style-type: none"> The zone causing the event is saved and can be identified by viewing MEMORY. Only one of the same consecutive zone warnings is saved, although the MEMORY display will flash each time (unless disabled by P94E option). Smart Beeps work in conjunction with any other Home and Day mode outputs, (as set by options P63E 1E-8E). Hint: Smart Beeps are most effective for smaller zone numbers, such as zones 1-8. Counting beeps from higher numbered zones, eg, zone 32, might be impractical. 	<p>Smart Beeps are available in Brief Home or Brief Day mode to identify zones by keypad beeps.</p> <p>When a Home zone or Day zone is triggered, the zone number is slowly beeped out, followed by 2 seconds of silence. This is repeated 3 times and can be stopped by another beep (such as keypad).</p> <p>If the zone has entry delay you will hear the Smart Beeps sequence once when the zone is triggered and again at the end of entry delay. If Entry Beeps are disabled (P60E 1E), Smart Beeps will only be heard at the end of entry delay.</p> <p>Smart Beeps use the keypad/s onboard sonalert, so option P63E 3E and/or 7E must be on to enable the sonalert output for Home alarms and Day alarms.</p> <table border="1"> <tr> <td style="background-color: #FF00FF;">KPX+</td> <td>P120E 6E to enable/disable the option</td> </tr> <tr> <td style="background-color: #00FF00;">NAVIGATOR</td> <td>P120E > enable/disable 6E</td> </tr> <tr> <td style="background-color: #00BFFF;">SMS*</td> <td>P[MasterCode]E P[InstallerCode]E P120E 6E</td> </tr> </table>	KPX+	P120E 6E to enable/disable the option	NAVIGATOR	P120E > enable/disable 6E	SMS*	P[MasterCode]E P[InstallerCode]E P120E 6E
KPX+	P120E 6E to enable/disable the option						
NAVIGATOR	P120E > enable/disable 6E						
SMS*	P[MasterCode]E P[InstallerCode]E P120E 6E						
P120E 7E	ENTRY DELAY EXTENDER						
<p>PROGRAM MODE LEVEL Installer</p> <p>FACTORY DEFAULT OFF</p> <p>RELATED OPTIONS P26E Entry Delay Time1.</p>	<p>When enabled, this option increases the Entry Delay Time1 by a factor of 10. Example, if P26E is programmed for 30 sec, it becomes 300 sec. (Entry Delay Time2 is unaffected).</p> <table border="1"> <tr> <td style="background-color: #FF00FF;">KPX+</td> <td>P120E 7E to enable/disable the option</td> </tr> <tr> <td style="background-color: #00FF00;">NAVIGATOR</td> <td>P120E > enable/disable 7E</td> </tr> <tr> <td style="background-color: #00BFFF;">SMS*</td> <td>P[MasterCode]E P[InstallerCode]E P120E 7E</td> </tr> </table>	KPX+	P120E 7E to enable/disable the option	NAVIGATOR	P120E > enable/disable 7E	SMS*	P[MasterCode]E P[InstallerCode]E P120E 7E
KPX+	P120E 7E to enable/disable the option						
NAVIGATOR	P120E > enable/disable 7E						
SMS*	P[MasterCode]E P[InstallerCode]E P120E 7E						
P120E 8E	AREA2 DISARM BY KEYSWITCH ALLOWED						
<p>PROGRAM MODE LEVEL Installer</p> <p>FACTORY DEFAULT OFF</p> <p>RELATED OPTIONS P60E 2E, 3E. P120E 1E, 4E, 5E</p>	<p>This option allows the keypad (if enabled) to disarm Area2. Note, the keypad cannot arm Area2, only disarm. Though it can both arm & disarm Area1.</p> <table border="1"> <tr> <td style="background-color: #FF00FF;">KPX+</td> <td>P120E 8E to enable/disable the option</td> </tr> <tr> <td style="background-color: #00FF00;">NAVIGATOR</td> <td>P120E > enable/disable 8E</td> </tr> <tr> <td style="background-color: #00BFFF;">SMS*</td> <td>P[MasterCode]E P[InstallerCode]E P120E 8E</td> </tr> </table>	KPX+	P120E 8E to enable/disable the option	NAVIGATOR	P120E > enable/disable 8E	SMS*	P[MasterCode]E P[InstallerCode]E P120E 8E
KPX+	P120E 8E to enable/disable the option						
NAVIGATOR	P120E > enable/disable 8E						
SMS*	P[MasterCode]E P[InstallerCode]E P120E 8E						

* SMS programming and operation requires the optional 106-985 4G Module

PROGRAMMING

AUX1 OUTPUT OPTIONS

Only one of the P121E options may be selected.

Option No.	Description	Default
P121E 1E	Zone alarms to AUX1 (P58E selects zones)	ON
2E	Zone Supervision alarms to AUX1	OFF
3E	Radio key Panic TOGGLE	OFF
4E	Radio key Panic PULSE	OFF
5E	[not used]	OFF
6E	[not used]	OFF
7E	Door Open Too Long (DOTL) alarm to AUX1	OFF
8E	Reader [x] output pulses AUX1	OFF

Any or all of the P141E options may be selected.

Option No.	Description	Default
P141E 1E	Area 1 Armed to AUX1	OFF
2E	Area 2 Armed to AUX1	OFF
3E	Home Armed to AUX1	OFF
4E	Keypad toggles AUX1	OFF
5E	[not used]	OFF
6E	[not used]	OFF
7E	[not used]	OFF
8E	Pulse AUX1	OFF

P121E	AUX1 OPTIONS 1E - 8E						
<p>PROGRAM MODE LEVEL Installer</p> <p>FACTORY DEFAULT 1E on.</p> <p>NOTES Only one option can be on. Turning an option on turns off another.</p> <p>RELATED OPTIONS P141E 1E-8E, P354E 5E-6E, P359E 5E-6E, P364E 5E-6E, P369E 5E-6E</p>	<p>Enable or disable P121E 1E to 8E as required. Only one option can be on.</p> <table border="1"> <tr> <td>KPX+</td> <td>P121E 1E - 8E to enable/disable the option as required</td> </tr> <tr> <td>NAVIGATOR</td> <td>P121E > enable/disable 1E - 8E as required</td> </tr> <tr> <td>SMS*</td> <td>P[MasterCode]E P[InstallerCode]E P121E [1E -8E] as required</td> </tr> </table>	KPX+	P121E 1E - 8E to enable/disable the option as required	NAVIGATOR	P121E > enable/disable 1E - 8E as required	SMS*	P[MasterCode]E P[InstallerCode]E P121E [1E -8E] as required
KPX+	P121E 1E - 8E to enable/disable the option as required						
NAVIGATOR	P121E > enable/disable 1E - 8E as required						
SMS*	P[MasterCode]E P[InstallerCode]E P121E [1E -8E] as required						
<p>P121E 1E</p> <p>RELATED OPTIONS P58E Aux1,3 zones</p>	<p>ZONE ALARMS TO AUX1</p> <p>With this option ON, zones selected in P58E will turn on Aux1 when they go into alarm. The Aux1 output turns off when the panel is disarmed/reset.</p>						
<p>P121E 2E</p> <p>RELATED OPTIONS P65E, P66E, P67E Radio Supervision</p>	<p>ZONE SUPERVISION ALARMS TO AUX1</p> <p>With this option ON, the AUX1 output will turn on when a SUPERVISED RADIO alarm is triggered. The Aux1 output turns off when the panel is disarmed/reset.</p>						
<p>P121E 3E</p> <p>NOTES When this option is on, Radio Key Panic buttons will no longer sound alarms or report alarms by communicator.</p> <p>RELATED OPTIONS P350E to P369E. AutoTimers 1 to 4.</p>	<p>ENABLE AUX1 FOR AUTOTIMER / RADIO KEY PANIC TOGGLES AUX1</p> <p>Dual action programming option. When this option is on, AUX1 is enabled for use by AutoTimer and Radio Key/s Panic button will TOGGLE the Aux1 output.</p>						
<p>P121E 4E</p> <p>NOTES When this option is on, Radio Key Panic buttons will no longer sound alarms or report alarms by communicator.</p> <p>RELATED OPTIONS P145E AUX1 Timer</p>	<p>RADIO KEY PANIC PULSES AUX1</p> <p>When this option is on, Radio Key/s Panic (button 5) will PULSE the Aux1 output.</p>						
<p>P121E 7E</p> <p>RELATED OPTIONS P303E DOTL zones. P304E DOTL timer.</p>	<p>DOOR OPEN TOO LONG (DOTL) ALERTS TO AUX1</p> <p>This option enables DOTL zones (P303E) to turn on Aux1 when the DOTL Time (P304E) expires.</p>						
<p>P121E 8E</p> <p>RELATED OPTIONS P318E, P328E, P338E, P319E, P329E, P339E.</p>	<p>READER PULSES AUX1</p> <p>This option enables an access control reader to pulse Aux1 when a valid access card is presented. Set the reader using P318E, P328E or P338E.</p>						

* SMS programming and operation requires the optional 106-985 4G Module

AUX1 OUTPUT OPTIONS

P141E	ENHANCED AUX1 OPTIONS						
PROGRAM MODE LEVEL Installer FACTORY DEFAULT All off. NOTES Any or all options may be selected on.	Enable or disable P141E 1E to 8E as required. Multiple options can be selected. <table border="1" style="margin-top: 10px;"> <tr> <td style="background-color: #e91e63; color: white;">KPX+</td> <td>P141E 1E - 8E to enable/disable the option as required</td> </tr> <tr> <td style="background-color: #4caf50; color: white;">NAVIGATOR</td> <td>P141E > enable/disable 1E - 8E as required</td> </tr> <tr> <td style="background-color: #00bcd4; color: white;">SMS*</td> <td>P[MasterCode]E P[InstallerCode]E P141E [1E -8E] as required</td> </tr> </table>	KPX+	P141E 1E - 8E to enable/disable the option as required	NAVIGATOR	P141E > enable/disable 1E - 8E as required	SMS*	P[MasterCode]E P[InstallerCode]E P141E [1E -8E] as required
KPX+	P141E 1E - 8E to enable/disable the option as required						
NAVIGATOR	P141E > enable/disable 1E - 8E as required						
SMS*	P[MasterCode]E P[InstallerCode]E P141E [1E -8E] as required						
P141E 1E	AREA 1 ARMED TO AUX1						
	Turns on AUX1 while Area 1 is armed.						
P141E 2E	AREA 2 ARMED TO AUX1						
	Turns on AUX1 while Area 2 is armed.						
P141E 3E	HOME ARMED TO AUX1						
	Turns on AUX1 while armed in Home mode.						
P141E 4E	KEYPAD TOGGLE AUX1						
	Applies to KPX+ Keypad and Saturn Keypad. When this option is on, AUX1 is turned ON or PULSED with the keypress 11* (* = Left hand STAR button). AUX1 is turned OFF with the keypress 11# (# = Right hand STAR button).						
P141E 8E	PULSE AUX1						
RELATED OPTIONS P145E, AUX1 Pulse Time. P141E 4E must also be ON for this option to work	This option converts the P121E 1E and the P141E 1E, 2E, 3E, 4E, 5E options into a pulsed AUX1 output. AUX1 is pulsed on for the time set in P145E.						

Option No.	Description	Default	Note
P145E	AUX1 TIMER	20 sec	1 to 99 seconds

P145E	AUX1 TIMER						
PROGRAM MODE LEVEL Installer FACTORY DEFAULT 20 sec. RELATED OPTIONS P141E 8E	Sets the length of pulse time for the AUX1 output when the P141E 8E option is selected. Select 1 to 99 seconds. <table border="1" style="margin-top: 10px;"> <tr> <td style="background-color: #e91e63; color: white;">KPX+</td> <td>P145E [New Time] E</td> </tr> <tr> <td style="background-color: #4caf50; color: white;">NAVIGATOR</td> <td>P145E > [New Time] E</td> </tr> <tr> <td style="background-color: #00bcd4; color: white;">SMS*</td> <td>P[MasterCode]E P[InstallerCode]E P145E [NewTime] E</td> </tr> </table>	KPX+	P145E [New Time] E	NAVIGATOR	P145E > [New Time] E	SMS*	P[MasterCode]E P[InstallerCode]E P145E [NewTime] E
KPX+	P145E [New Time] E						
NAVIGATOR	P145E > [New Time] E						
SMS*	P[MasterCode]E P[InstallerCode]E P145E [NewTime] E						

* SMS programming and operation requires the optional 106-985 4G Module

PROGRAMMING

AUX2 OUTPUT OPTIONS

Only one of the P122E options may be selected.

Option No.	Description	Default
P122E 1E	Zone alarms to Aux2	ON
2E	Zone Supervision alarms to Aux2	OFF
3E	AutoTimer + R/Key Panic TOGGLES Aux2	OFF
4E	Radio Key AUX button Pulses Aux2	OFF
5E	[not used]	OFF
6E	[not used]	OFF
7E	DOTL alerts to Aux2	OFF
8E	Reader output pulses Aux2	OFF

Any or all of the P142E options may be selected.

Option No.	Description	Default
P142E 1E	Area1 Armed to AUX2	OFF
2E	Area2 Armed to AUX2	OFF
3E	Home Mode arm to AUX2	OFF
4E	Keypad toggles AUX2	OFF
5E	[not used]	OFF
6E	[not used]	OFF
7E	[not used]	OFF
8E	Pulse AUX2	OFF

P122E	AUX2 OPTIONS 1E - 8E						
<p>PROGRAM MODE LEVEL Installer</p> <p>FACTORY DEFAULT 1E on.</p> <p>NOTES Only one option can be on. Turning an option on turns off another.</p> <p>RELATED OPTIONS P142E 1E-8E, P354E 7E-8E, P359E 7E-8E, P364E 7E-8E, P369E 7E-8E</p>	<p>P122E is one of several options which control the behaviour of the AUX2 output. One of the most powerful features of DPlus panels is the flexibility to control the AUX outputs by various events and alarms. If the AUX2 output does not behave as expected, please check all related options such as AutoTimers and P142E options.</p> <p>Enable or disable P122E 1E to 8E as required. Only one option can be on.</p> <table border="1"> <tr> <td style="background-color: #ff69b4;">KPX+</td> <td>P122E 1E - 8E to enable/disable the option as required</td> </tr> <tr> <td style="background-color: #32cd32;">NAVIGATOR</td> <td>P122E > enable/disable 1E - 8E as required</td> </tr> <tr> <td style="background-color: #1e90ff;">SMS*</td> <td>P[MasterCode]E P[InstallerCode]E P122E [1E -8E] as required</td> </tr> </table>	KPX+	P122E 1E - 8E to enable/disable the option as required	NAVIGATOR	P122E > enable/disable 1E - 8E as required	SMS*	P[MasterCode]E P[InstallerCode]E P122E [1E -8E] as required
KPX+	P122E 1E - 8E to enable/disable the option as required						
NAVIGATOR	P122E > enable/disable 1E - 8E as required						
SMS*	P[MasterCode]E P[InstallerCode]E P122E [1E -8E] as required						
P122E 1E	ZONE ALARMS TO AUX2						
<p>RELATED OPTIONS P59E Aux2 zones.</p>	<p>With this option ON, zones selected in P59E will turn on Aux2 when they go into alarm. The Aux2 output turns off when the panel is disarmed/reset.</p>						
P122E 2E	ZONE SUPERVISION ALARMS TO AUX2						
<p>RELATED OPTIONS P65E, P66E, P67E Radio Supervision.</p>	<p>Setting this option turns the AUX2 output ON when a SUPERVISED RADIO alarm is triggered. The Aux2 output turns off when the panel is disarmed/reset.</p>						
P122E 3E	ENABLE AUX2 FOR AUTOTIMER / RADIO KEY AUX TOGGLES AUX2						
<p>RELATED OPTIONS P350E to P369E. AutoTimers 1 to 4.</p>	<p>Dual action programming option.</p> <p>When this option is on, AUX2 is enabled for use by AutoTimer and Radio Key/s AUX button will TOGGLE the AUX2 output.</p>						
P122E 4E	RADIO KEY AUX BUTTON PULSE AUX2						
<p>RELATED OPTIONS P146E AUX2 Timer</p>	<p>When this option is on, Radio Key/s AUX button 3 will PULSE the Aux2 output.</p>						
P122E 7E	DOOR OPEN TOO LONG (DOTL) ALERTS TO AUX2						
<p>RELATED OPTIONS P303E DOTL zones. P304E DOTL timer.</p>	<p>This option enables DOTL zones (P303E) to turn on AUX2 when the DOTL Time (P304E) expires.</p>						
P122E 8E	READER OUTPUT TO AUX2						
<p>RELATED OPTIONS P318E, P328E, P338E, P319E, P329E, P339E.</p>	<p>This option enables an access control reader to pulse Aux2 when a valid access card is presented. Set the reader using P318E, P328E or P338E.</p>						

* SMS programming and operation requires the optional 106-985 4G Module

AUX2 OUTPUT OPTIONS

P142E	ENHANCED AUX2 OPTIONS						
PROGRAM MODE LEVEL Installer FACTORY DEFAULT All off. NOTES Any or all options may be selected on.	The P142E enhanced AUX2 options work along with P122E and AutoTimers to provide multiple choices of events and alarms to control AUX2.						
	<table border="1"> <tr> <td style="background-color: #e91e63; color: white;">KPX+</td> <td>P141E 1E - 8E to enable/disable the option as required</td> </tr> <tr> <td style="background-color: #4caf50; color: white;">NAVIGATOR</td> <td>P141E > enable/disable 1E - 8E as required</td> </tr> <tr> <td style="background-color: #00bcd4; color: white;">SMS*</td> <td>P[MasterCode]E P[InstallerCode]E P141E [1E -8E] as required</td> </tr> </table>	KPX+	P141E 1E - 8E to enable/disable the option as required	NAVIGATOR	P141E > enable/disable 1E - 8E as required	SMS*	P[MasterCode]E P[InstallerCode]E P141E [1E -8E] as required
KPX+	P141E 1E - 8E to enable/disable the option as required						
NAVIGATOR	P141E > enable/disable 1E - 8E as required						
SMS*	P[MasterCode]E P[InstallerCode]E P141E [1E -8E] as required						
P142E 1E	AREA1 ARMED TO AUX2 Turns on AUX2 while Area 1 is armed.						
P142E 2E	AREA2 ARMED TO AUX2 Turns on AUX2 while Area 2 is armed.						
P142E 3E	HOME ARMED TO AUX2 Turns on AUX2 while armed in Home mode.						
P142E 4E	KEYPAD TOGGLE AUX2 Applies to KPX+ Keypad and Saturn Keypad. When this option is on, AUX2 is turned ON or PULSED with the keypress 22* (* = Left hand STAR button). AUX2 is turned OFF with the keypress 22# (# = Right hand STAR button).						
P142E 8E	PULSE AUX2 This option converts the P122E 1E and the P142E 1E, 2E, 3E, 4E, 5E options into a pulsed AUX2 output. AUX2 is pulsed on for the time set in P146E.						
RELATED OPTIONS P146E, AUX2 Pulse Time. P142E 4E must also be ON for this option to work							

Option No.	Description	Default	Note
P146E	AUX2 TIMER	20 sec	1 to 99 seconds

P146E	AUX2 TIMER						
PROGRAM MODE LEVEL Installer FACTORY DEFAULT 20 sec. RELATED OPTIONS P142E 8E	Sets the length of pulse time for the AUX2 output when the P142E 8E option is selected. Select 1 to 99 seconds.						
	<table border="1"> <tr> <td style="background-color: #e91e63; color: white;">KPX+</td> <td>P146E [New Time] E</td> </tr> <tr> <td style="background-color: #4caf50; color: white;">NAVIGATOR</td> <td>P146E > [New Time] E</td> </tr> <tr> <td style="background-color: #00bcd4; color: white;">SMS*</td> <td>P[MasterCode]E P[InstallerCode]E P146E [NewTime] E</td> </tr> </table>	KPX+	P146E [New Time] E	NAVIGATOR	P146E > [New Time] E	SMS*	P[MasterCode]E P[InstallerCode]E P146E [NewTime] E
KPX+	P146E [New Time] E						
NAVIGATOR	P146E > [New Time] E						
SMS*	P[MasterCode]E P[InstallerCode]E P146E [NewTime] E						

* SMS programming and operation requires the optional 106-985 4G Module

PROGRAMMING

AUX3 OUTPUT OPTIONS

Only one of the P123E options may be selected.

Option No.	Description	Default
P123E 1E	Zone Alarms to AUX3	OFF
2E	[not used]	OFF
3E	Enable AUX3 for AutoTimer	OFF
4E	Radio Key Panic Pulses AUX3	OFF
5E	[not used]	OFF
6E	[not used]	OFF
7E	[not used]	OFF
8E	Reader output pulses Aux3	OFF

Any or all of the P143E options may be selected.

Option No.	Description	Default
P143E 1E	Area1 Armed to AUX3	OFF
2E	Area2 Armed to AUX3	OFF
3E	Home Mode arm to AUX3	OFF
4E	Keypad toggles AUX3	OFF
5E	[not used]	OFF
6E	[not used]	OFF
7E	[not used]	OFF
8E	Pulse AUX3	OFF

P123E	AUX3 OPTIONS 1E - 8E						
<p>PROGRAM MODE LEVEL Installer</p> <p>FACTORY DEFAULT 1E on.</p> <p>NOTES Only one option can be on. Turning an option on turns off another.</p> <p>RELATED OPTIONS P143E 1E-8E Enhanced AUX3 options. P374E 5E-6E AutoTimer1 AUX3 options. P379E 5E-6E AutoTimer2 AUX3 options. P384E 5E-6E AutoTimer3 AUX3 options. P389E 5E-6E AutoTimer4 AUX3 options.</p>	<p>P123E is one of several options which control the behaviour of the AUX3 output. Enable or disable P123E 1E to 8E as required. Only one option can be on.</p> <table border="1" style="width: 100%;"> <tr> <td style="background-color: #ff69b4; color: white; text-align: center;">KPX+</td> <td>P123E 1E - 8E to enable/disable the option as required</td> </tr> <tr> <td style="background-color: #90ee90; color: white; text-align: center;">NAVIGATOR</td> <td>P123E > enable/disable 1E - 8E as required</td> </tr> <tr> <td style="background-color: #6495ed; color: white; text-align: center;">SMS*</td> <td>P[MasterCode]E P[InstallerCode]E P123E [1E -8E] as required</td> </tr> </table>	KPX+	P123E 1E - 8E to enable/disable the option as required	NAVIGATOR	P123E > enable/disable 1E - 8E as required	SMS*	P[MasterCode]E P[InstallerCode]E P123E [1E -8E] as required
KPX+	P123E 1E - 8E to enable/disable the option as required						
NAVIGATOR	P123E > enable/disable 1E - 8E as required						
SMS*	P[MasterCode]E P[InstallerCode]E P123E [1E -8E] as required						
P123E 1E	ZONE ALARMS TO AUX3						
<p>RELATED OPTIONS P58E Aux1,3 zones. P121E 1E Zone Alarms to AUX1.</p>	<p>With this option ON, zones selected in P58E will turn on Aux3 when they go into alarm. The Aux3 output turns off when the panel is disarmed/reset.</p> <p>P121E 1E must be OFF for this option to work.</p>						
P123E 3E	ENABLE AUX3 FOR AUTOTIMER						
<p>RELATED OPTIONS P370E to P389E. AutoTimers</p>	<p>When this option is on, AUX3 is enabled for use by AutoTimer.</p>						
P123E 4E	RADIO KEY PANIC PULSES AUX3						
<p>NOTES When this option is on, Radio Key Panic buttons will no longer sound alarms or report alarms by communicator.</p> <p>RELATED OPTIONS P147E AUX3 Timer</p>	<p>When this option is on, Radio Key/s Panic button will PULSE the Aux3 output. Note that P121E 4E (Radio Key Panic Pulses AUX1) over-rides this option.</p>						
P123E 8E	READER OUTPUT TO AUX3						
<p>RELATED OPTIONS P318E, P328E, P338E, P319E, P329E, P339E.</p>	<p>This option enables an access control reader to pulse Aux3 when a valid access card is presented. Set the reader using P318E, P328E or P338E.</p>						

* SMS programming and operation requires the optional 106-985 4G Module

AUX3 OUTPUT OPTIONS

P143E	ENHANCED AUX3 OPTIONS						
PROGRAM MODE LEVEL Installer FACTORY DEFAULT All off. NOTES Any or all options may be selected on.	The P143E enhanced AUX3 options work along with P123E and AutoTimers to provide multiple choices of events and alarms to control AUX3.						
	<table border="1"> <tr> <td style="background-color: #e91e63; color: white;">KPX+</td> <td>P143E 1E - 8E to enable/disable the option as required</td> </tr> <tr> <td style="background-color: #4caf50; color: white;">NAVIGATOR</td> <td>P143E > enable/disable 1E - 8E as required</td> </tr> <tr> <td style="background-color: #00bcd4; color: white;">SMS*</td> <td>P[MasterCode]E P[InstallerCode]E P143E [1E -8E] as required</td> </tr> </table>	KPX+	P143E 1E - 8E to enable/disable the option as required	NAVIGATOR	P143E > enable/disable 1E - 8E as required	SMS*	P[MasterCode]E P[InstallerCode]E P143E [1E -8E] as required
KPX+	P143E 1E - 8E to enable/disable the option as required						
NAVIGATOR	P143E > enable/disable 1E - 8E as required						
SMS*	P[MasterCode]E P[InstallerCode]E P143E [1E -8E] as required						
P143E 1E	AREA1 ARMED TO AUX3 Turns on AUX3 while Area 1 is armed.						
P143E 2E	AREA2 ARMED TO AUX3 Turns on AUX3 while Area 2 is armed.						
P143E 3E	HOME ARMED TO AUX3 Turns on AUX3 while armed in Home mode.						
P143E 4E	KEYPAD TOGGLES AUX3 Applies to KPX+ Keypad and Saturn Keypad. When this option is on, AUX3 is turned ON or PULSED with the keypress 33* (* = Left hand STAR button). AUX3 is turned OFF with the keypress 33# (# = Right hand STAR button).						
P143E 8E	PULSE AUX3 This option converts the P143E 1E, 2E, 3E, 4E, 5E options into a pulsed AUX3 output. AUX3 is pulsed on for the time set in P147E.						
RELATED OPTIONS P147E, AUX3 Pulse Time. P143E 4E must also be ON for this option to work							

Option No.	Description	Default	Note
P147E	AUX3 TIMER	20 sec	1 to 99 seconds

P147E	AUX3 TIMER						
PROGRAM MODE LEVEL Installer FACTORY DEFAULT 20 sec. RELATED OPTIONS P143E 8E	Sets the length of pulse time for the AUX3 output when the P143E 8E option is selected. Select 1 to 99 seconds.						
	<table border="1"> <tr> <td style="background-color: #e91e63; color: white;">KPX+</td> <td>P147E [New Time] E</td> </tr> <tr> <td style="background-color: #4caf50; color: white;">NAVIGATOR</td> <td>P147E > [New Time] E</td> </tr> <tr> <td style="background-color: #00bcd4; color: white;">SMS*</td> <td>P[MasterCode]E P[InstallerCode]E P147E [NewTime] E</td> </tr> </table>	KPX+	P147E [New Time] E	NAVIGATOR	P147E > [New Time] E	SMS*	P[MasterCode]E P[InstallerCode]E P147E [NewTime] E
KPX+	P147E [New Time] E						
NAVIGATOR	P147E > [New Time] E						
SMS*	P[MasterCode]E P[InstallerCode]E P147E [NewTime] E						

* SMS programming and operation requires the optional 106-985 4G Module

PROGRAMMING

AUX4 OUTPUT OPTIONS

Only one of the P124E options may be selected.

Option No.	Description	Default
P124E 1E	Zone Alarms to AUX4	OFF
2E	Enable Extension Sonalert	OFF
3E	Enable AUX4 for AutoTimer	OFF
4E	Radio Key AUX Pulses AUX4	OFF
5E	[not used]	OFF
6E	[not used]	OFF
7E	[not used]	OFF
8E	Reader output pulses AUX4	OFF

Any or all of the P144E options may be selected.

Option No.	Description	Default
P144E 1E	Area1 Armed to AUX4	OFF
2E	Area2 Armed to AUX4	OFF
3E	Home Mode arm to AUX4	OFF
4E	Keypad toggles AUX4	OFF
5E	[not used]	OFF
6E	[not used]	OFF
7E	[not used]	OFF
8E	Pulse AUX4	OFF

P124E	AUX4 OPTIONS 1E - 8E						
<p>PROGRAM MODE LEVEL Installer</p> <p>FACTORY DEFAULT 1E on.</p> <p>NOTES Only one option can be on. Turning an option on turns off another.</p> <p>RELATED OPTIONS P144E 1E-8E Enhanced AUX4 options. P374E 7E-8E AutoTimer1 AUX4 options. P379E 7E-8E AutoTimer2 AUX4 options. P384E 7E-8E AutoTimer3 AUX4 options. P389E 7E-8E AutoTimer4 AUX4 options.</p>	<p>P124E is one of several options which control the behaviour of the AUX4 output. Enable or disable P124E 1E to 8E as required. Only one option can be on.</p> <table border="1"> <tr> <td style="background-color: #ff00ff; color: white;">KPX+</td> <td>P124E 1E - 8E to enable/disable the option as required</td> </tr> <tr> <td style="background-color: #00ff00; color: white;">NAVIGATOR</td> <td>P124E > enable/disable 1E - 8E as required</td> </tr> <tr> <td style="background-color: #00bfff; color: white;">SMS*</td> <td>P[MasterCode]E P[InstallerCode]E P124E [1E -8E] as required</td> </tr> </table>	KPX+	P124E 1E - 8E to enable/disable the option as required	NAVIGATOR	P124E > enable/disable 1E - 8E as required	SMS*	P[MasterCode]E P[InstallerCode]E P124E [1E -8E] as required
KPX+	P124E 1E - 8E to enable/disable the option as required						
NAVIGATOR	P124E > enable/disable 1E - 8E as required						
SMS*	P[MasterCode]E P[InstallerCode]E P124E [1E -8E] as required						
P124E 1E	ZONE ALARMS TO AUX4						
<p>RELATED OPTIONS P59E Aux2/4 zones. P122E 1E Zone Alarms to AUX2</p>	<p>With this option ON, zones selected in P59E will turn on Aux4 when they go into alarm. The Aux4 output turns off when the panel is disarmed/reset.</p> <p>P122E 1E must be OFF for this option to work.</p>						
P124E 2E	ENABLE EXTENSION SONALERT						
<p>NOTES A standard 12V sonalert or other low current sounder can be used as the extension beeper.</p>	<p>Enables the Aux4 output to duplicate all keypad beeps including keypress beeps. This is useful in cases where, for example, entry beeps or other keypad beeps need to be heard in more than one location on the premises. (Adding an additional keypad would also achieve the same result).</p>						
P124E 3E	ENABLE AUX4 FOR AUTOTIMER						
<p>RELATED OPTIONS P370E to P389E. AutoTimers.</p>	<p>When this option is on, AUX4 is enabled for use by AutoTimer.</p>						
P124E 4E	RADIO KEY AUX PULSES AUX4						
<p>RELATED OPTIONS P148E AUX4 Timer</p>	<p>When this option is on, Radio Key/s AUX button will PULSE the Aux4 output.</p>						
P124E 8E	READER OUTPUT TO AUX4						
<p>RELATED OPTIONS P318E, P328E, P338E, P319E, P329E, P339E.</p>	<p>This option enables an access control reader to pulse AUX4 when a valid access card is presented. Set the reader using P318E, P328E or P338E.</p>						

* SMS programming and operation requires the optional 106-985 4G Module

AUX4 OUTPUT OPTIONS

P144E	ENHANCED AUX4 OPTIONS						
PROGRAM MODE LEVEL Installer FACTORY DEFAULT All off. NOTES Any or all options may be selected on.	The P144E enhanced AUX4 options work along with P124E and AutoTimers to provide multiple choices of events and alarms to control AUX4. <table border="1" style="margin-top: 10px;"> <tr> <td style="background-color: #FF00FF; color: white;">KPX+</td> <td>P144E 1E - 8E to enable/disable the option as required</td> </tr> <tr> <td style="background-color: #00FF00; color: white;">NAVIGATOR</td> <td>P144E > enable/disable 1E - 8E as required</td> </tr> <tr> <td style="background-color: #00BFFF; color: white;">SMS*</td> <td>P[MasterCode]E P[InstallerCode]E P144E [1E -8E] as required</td> </tr> </table>	KPX+	P144E 1E - 8E to enable/disable the option as required	NAVIGATOR	P144E > enable/disable 1E - 8E as required	SMS*	P[MasterCode]E P[InstallerCode]E P144E [1E -8E] as required
KPX+	P144E 1E - 8E to enable/disable the option as required						
NAVIGATOR	P144E > enable/disable 1E - 8E as required						
SMS*	P[MasterCode]E P[InstallerCode]E P144E [1E -8E] as required						
P144E 1E	AREA1 ARMED TO AUX4 Turns on AUX4 while Area 1 is armed.						
P144E 2E	AREA2 ARMED TO AUX4 Turns on AUX4 while Area 2 is armed.						
P144E 3E	HOME ARMED TO AUX4 Turns on AUX4 while armed in Home mode.						
P144E 4E	KEYPAD TOGGLES AUX4 When this option is on, AUX4 is turned ON or PULSED with the keypress 44* (* = Left hand STAR button). AUX4 is turned OFF with the keypress 44# (# = Right hand STAR button).						
P144E 8E	PULSE AUX4 This option converts the P144E 1E, 2E, 3E, 4E, 5E options into a pulsed AUX4 output. AUX4 is pulsed on for the time set in P148E.						
RELATED OPTIONS P148E, AUX4 Pulse Time. P144E 4E must also be ON for this option to work							

Option No.	Description	Default	Note
P148E	AUX4 TIMER	20 sec	1 to 99 seconds

P148E	AUX4 TIMER						
PROGRAM MODE LEVEL Installer FACTORY DEFAULT 20 sec. RELATED OPTIONS P144E 8E	Sets the length of pulse time for the AUX4 output when the P144E 8E option is selected. Select 1 to 99 seconds. <table border="1" style="margin-top: 10px;"> <tr> <td style="background-color: #FF00FF; color: white;">KPX+</td> <td>P148E [New Time] E</td> </tr> <tr> <td style="background-color: #00FF00; color: white;">NAVIGATOR</td> <td>P148E > [New Time] E</td> </tr> <tr> <td style="background-color: #00BFFF; color: white;">SMS*</td> <td>P[MasterCode]E P[InstallerCode]E P148E [NewTime] E</td> </tr> </table>	KPX+	P148E [New Time] E	NAVIGATOR	P148E > [New Time] E	SMS*	P[MasterCode]E P[InstallerCode]E P148E [NewTime] E
KPX+	P148E [New Time] E						
NAVIGATOR	P148E > [New Time] E						
SMS*	P[MasterCode]E P[InstallerCode]E P148E [NewTime] E						

WIRING EXAMPLES

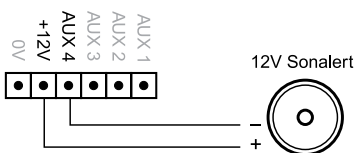

Aux4 driving an extension sonalert. See P124E 2E.

Use the optional 106-013 Relay Board

PROGRAMMING

AUX5, AUX6, AUX7, AUX8 OUTPUT OPTIONS

Option No.	Description	Default
P151E	4E Keypad toggles AUX5	OFF
	7E Reader Output to AUX5	OFF
	8E Pulse AUX5	OFF

Option No.	Description	Default
P152E	2E AUX+ key toggles AUX6	OFF
	3E AUX+ key Pulses AUX6	OFF
	4E Keypad toggles AUX6	OFF
	7E Reader Output to AUX6	OFF
	8E Pulse AUX6	OFF

P151E, P152E	AUX5, AUX6 OPTIONS						
PROGRAM MODE LEVEL Installer FACTORY DEFAULT As per table	Options for controlling AUX5 & AUX6 outputs on the optional 106-011 Output Expander/s. <table border="1"> <tr> <td>KPX+</td> <td>PxxE 1E - 8E to enable/disable the option as required</td> </tr> <tr> <td>NAVIGATOR</td> <td>PxxE > enable/disable 1E - 8E as required</td> </tr> <tr> <td>SMS*</td> <td>P[MasterCode]E P[InstallerCode]E PxxE [1E -8E] as required</td> </tr> </table>	KPX+	PxxE 1E - 8E to enable/disable the option as required	NAVIGATOR	PxxE > enable/disable 1E - 8E as required	SMS*	P[MasterCode]E P[InstallerCode]E PxxE [1E -8E] as required
KPX+	PxxE 1E - 8E to enable/disable the option as required						
NAVIGATOR	PxxE > enable/disable 1E - 8E as required						
SMS*	P[MasterCode]E P[InstallerCode]E PxxE [1E -8E] as required						
P151E 4E	KEYPAD TOGGLES AUX5						
RELATED OPTIONS P151E 8E	When this option is enabled, AUX5 on the Output Expander/s is turned ON using the Auxiliary Control menu on the Ness Navigator touch screen keypad or KPX+ and Saturn+ keypads. (55* toggles on, 55# toggles off) P151E 8E changes the operation to Pulse.						
P151E 7E	READER OUTPUT TO AUX5						
RELATED OPTIONS P318E, P328E, P338E, P319E, P329E, P339E	This option enables an access control reader to pulse AUX5 when a valid access card is presented. Set the reader using P318E, P328E or P338E.						
P151E 8E	PULSE AUX5						
RELATED OPTIONS P155E AUX5 output timer NOTE P151E 4E must also be on.	This option sets AUX5 to Pulse (momentary output) for any action that triggers AUX5 including keypad operation (see P151E 4E). Set the pulse on time using P155E.						

P152E 2E	RK5 AUX+ KEY TOGGLES AUX6
	When this option is enabled, AUX6 on the Output Expander/s is toggled by the AUX+ key (Button 4) on a Ness RK5 radio key.
P152E 3E	RK5 AUX+ KEY PULSES AUX6
	When this option is enabled, AUX6 on the Output Expander/s is pulsed by the AUX+ key (Button 4) on a Ness RK5 radio key.
P152E 4E	KEYPAD TOGGLES AUX6
	When this option is enabled, AUX6 on the Output Expander/s is turned ON using the Auxiliary Control menu on the Ness Navigator touch screen keypad or KPX+ and Saturn+ keypads. (66* toggles on, 66# toggles off) P152 E 8E changes the operation to Pulse.
P152E 7E	READER OUTPUT TO AUX6
RELATED OPTIONS P318E, P328E, P338E, P319E, P329E, P339E	This option enables an access control reader to pulse AUX6 when a valid access card is presented. Set the reader using P318E, P328E or P338E.
P152 8E	PULSE AUX6
RELATED OPTIONS P156E AUX6 output timer NOTE P152E 4E must also be on.	This option sets AUX6 to Pulse (momentary output) for any action that triggers AUX6 including keypad operation (see P152E 4E). Set the pulse on time using P156E. When using a keypad, 66* pulses the output.

* SMS programming and operation requires the optional 106-985 4G Module

Option No.	Description	Default	
P153E	4E	Keypad toggles AUX7	OFF
	7E	Reader Output to AUX7	OFF
	8E	Pulse AUX7	OFF

Option No.	Description	Default	
P154E	2E	AUX+ key toggles AUX8	OFF
	3E	AUX+ key Pulses AUX8	OFF
	4E	Keypad toggles AUX8	OFF
	7E	Reader Output to AUX8	OFF
	8E	Pulse AUX8	OFF

P153E	AUX7 OPTIONS						
PROGRAM MODE LEVEL Installer	Options for controlling AUX7 output on the optional 106-011 Output Expander/s.						
FACTORY DEFAULT As per table	<table border="1" style="width: 100%;"> <tr> <td style="background-color: #ff69b4; color: white; text-align: center;">KPX+</td> <td>P153E 1E - 8E to enable/disable the option as required</td> </tr> <tr> <td style="background-color: #32cd32; color: white; text-align: center;">NAVIGATOR</td> <td>P153E > enable/disable 1E - 8E as required</td> </tr> <tr> <td style="background-color: #00b0f0; color: white; text-align: center;">SMS*</td> <td>P[MasterCode]E P[InstallerCode]E P153E [1E -8E] as required</td> </tr> </table>	KPX+	P153E 1E - 8E to enable/disable the option as required	NAVIGATOR	P153E > enable/disable 1E - 8E as required	SMS*	P[MasterCode]E P[InstallerCode]E P153E [1E -8E] as required
KPX+	P153E 1E - 8E to enable/disable the option as required						
NAVIGATOR	P153E > enable/disable 1E - 8E as required						
SMS*	P[MasterCode]E P[InstallerCode]E P153E [1E -8E] as required						
P153E 4E	KEYPAD TOGGLES AUX7						
RELATED OPTIONS P153E 8E	When this option is enabled, AUX7 on the Output Expander/s is turned ON using the Auxiliary Control menu on the Ness Navigator touch screen keypad or KPX+ and Saturn+ keypads. (77* toggles on, 77# toggles off) P153E 8E changes the operation to Pulse.						
P153E 7E	READER OUTPUT TO AUX7						
RELATED OPTIONS P318E, P328E, P338E, P319E, P329E, P339E	This option enables an access control reader to pulse AUX7 when a valid access card is presented. Set the reader using P318E, P328E or P338E.						
P153E 8E	PULSE AUX7						
RELATED OPTIONS P157E AUX7 output timer	This option sets AUX7 to Pulse (momentary output) for any action that triggers AUX7 including keypad operation (see P153E 4E). Set the pulse on time using P157E.						
NOTE P153E 4E must also be on.							

P154E 2E	RK5 AUX+ KEY TOGGLES AUX8
	When this option is enabled, AUX8 on the Output Expander/s is toggled by the AUX+ key (Button 4) on a Ness RK5 radio key.
P154E 3E	RK5 AUX+ KEY PULSES AUX8
	When this option is enabled, AUX8 on the Output Expander/s is pulsed by the AUX+ key (Button 4) on a Ness RK5 radio key.
P154E 4E	KEYPAD TOGGLES AUX8
	When this option is enabled, AUX8 on the Output Expander/s is turned ON using the Auxiliary Control menu on the Ness Navigator touch screen keypad or KPX+ and Saturn+ keypads. (88* toggles on, 88# toggles off) P154 E 8E changes the operation to Pulse.
P154E 7E	READER OUTPUT TO AUX8
RELATED OPTIONS P318E, P328E, P338E, P319E, P329E, P339E	This option enables an access control reader to pulse AUX8 when a valid access card is presented. Set the reader using P318E, P328E or P338E.
P154 8E	PULSE AUX8
RELATED OPTIONS P158E AUX8 output timer	This option sets AUX8 to Pulse (momentary output) for any action that triggers AUX8 including keypad operation (see P154E 4E). Set the pulse on time using P158E.
NOTE P154E 4E must also be on.	When using a keypad, 88* pulses the output.

PROGRAMMING

Option No.	Description	Default	Note
P155E	AUX5 TIMER	20 sec	1 to 99 seconds
P156E	AUX6 TIMER	20 sec	1 to 99 seconds
P157E	AUX7 TIMER	20 sec	1 to 99 seconds
P158E	AUX8 TIMER	20 sec	1 to 99 seconds

P155E, P156E, P157E, P158E	AUX5 – AUX8 TIMERS						
<p>PROGRAM MODE LEVEL Installer</p> <p>FACTORY DEFAULT 20 sec.</p> <p>RELATED OPTIONS P151E 8E Pulse AUX5 P152E 8E Pulse AUX6 P153E 8E Pulse AUX7 P154E 8E Pulse AUX8</p>	<p>Sets the length of pulse time for the AUX5 – AUX8 outputs when the outputs are set for Pulse mode. Select 1 to 99 seconds.</p> <table border="1"> <tr> <td style="background-color: #FF00FF;">KPX+</td> <td>PxxxE [New Time] E</td> </tr> <tr> <td style="background-color: #00FF00;">NAVIGATOR</td> <td>PxxxE > [New Time] E</td> </tr> <tr> <td style="background-color: #00BFFF;">SMS*</td> <td>P[MasterCode]E P[InstallerCode]E PxxxE [NewTime] E</td> </tr> </table>	KPX+	PxxxE [New Time] E	NAVIGATOR	PxxxE > [New Time] E	SMS*	P[MasterCode]E P[InstallerCode]E PxxxE [NewTime] E
KPX+	PxxxE [New Time] E						
NAVIGATOR	PxxxE > [New Time] E						
SMS*	P[MasterCode]E P[InstallerCode]E PxxxE [NewTime] E						

Option No.	Description	Default	Note
P160E	ALARM SIREN VOLUME	99	1 to 99 levels
P161E	FIRE SIREN VOLUME	99	1 to 99 levels
P162E	CHIRP SIREN VOLUME	16	1 to 99 levels

P160E P161E P162E	ALARM SIREN VOLUME FIRE SIREN VOLUME CHIRP SIREN VOLUME						
<p>PROGRAM MODE LEVEL Installer</p> <p>FACTORY DEFAULT P160E: 99 P161E: 99 P162E: 16</p>	<p>Sets the audible volume level for the Siren output, Fire Siren, Chirp siren. Select volume from 1 (lowest) to 99 (highest).</p> <table border="1"> <tr> <td style="background-color: #FF00FF;">KPX+</td> <td>PxxE [New Value] E</td> </tr> <tr> <td style="background-color: #00FF00;">NAVIGATOR</td> <td>PxxE > [New Value] E</td> </tr> <tr> <td style="background-color: #00BFFF;">SMS*</td> <td>P[MasterCode]E P[InstallerCode]E PxxE [NewValue] E</td> </tr> </table>	KPX+	PxxE [New Value] E	NAVIGATOR	PxxE > [New Value] E	SMS*	P[MasterCode]E P[InstallerCode]E PxxE [NewValue] E
KPX+	PxxE [New Value] E						
NAVIGATOR	PxxE > [New Value] E						
SMS*	P[MasterCode]E P[InstallerCode]E PxxE [NewValue] E						

Option No.	Description	ZONES 1–8								ZONES 9-32 IF FITTED							
		1	2	3	4	5	6	7	8	9	10	11	31	31	32
P125E	ENABLE HARDWIRED ZONES	ON	ON	ON	ON	ON	ON	ON	ON	ON	ON	ON	ON	ON	ON	ON	ON

P125E	ENABLE HARDWIRED ZONES						
<p>PROGRAM MODE LEVEL Installer</p> <p>FACTORY DEFAULT All on.</p> <p>NOTES THIS OPTION APPLIES ONLY TO WIRED ZONES AND HAS NO EFFECT ON RADIO ZONES.</p> <p>KPX+ PRO TIP When selecting zones, MEMORY E selects all, 0 E deselects all.</p>	<p>This option allows hardwired zone inputs to be enabled or disabled. Zones 1-8 are standard on the DPlus Main Zones 9-24 are available locally on the optional L-24 expander Zones 9-16 available on the optional L-16 local expander Zones 17-32 available on the optional R-16 remote expander Disabled zones are ignored by the panel eliminating the need for EOL resistors. This option has no effect on radio zones.</p> <table border="1"> <tr> <td style="background-color: #FF00FF;">KPX+</td> <td>P125E [Zone Number] E to enable/disable zones</td> </tr> <tr> <td style="background-color: #00FF00;">NAVIGATOR</td> <td>P125E > Select zones</td> </tr> <tr> <td style="background-color: #00BFFF;">SMS*</td> <td>P[MasterCode]E P[InstallerCode]E P125E [Zone Number] E</td> </tr> </table>	KPX+	P125E [Zone Number] E to enable/disable zones	NAVIGATOR	P125E > Select zones	SMS*	P[MasterCode]E P[InstallerCode]E P125E [Zone Number] E
KPX+	P125E [Zone Number] E to enable/disable zones						
NAVIGATOR	P125E > Select zones						
SMS*	P[MasterCode]E P[InstallerCode]E P125E [Zone Number] E						

* SMS programming and operation requires the optional 106-985 4G Module

P126E	1E	Enable Double key PANIC	ON
	2E	Enable Double key FIRE	OFF
	3E	Enable Double key MEDICAL & Nav MEDICAL	OFF
	4E	Enable Entry Chime, DAY Mode	OFF
	5E	Enable Entry Chime, HOME Mode	OFF
	8E	Disable One Digit At A Time display	ON

P126E	MISC KEYPAD OPTIONS						
<p>PROGRAM MODE LEVEL Installer</p> <p>FACTORY DEFAULT 1E on. Double key Panic enabled. 2E – 5E off. 8E on.</p> <p>NOTES</p> <ul style="list-style-type: none"> • One or all options can be enabled. • To operate KPX/Saturn double key functions - in normal operating mode press and hold the matching keys for at least 1.5sec. 	<p>Various programming options for Ness KPX+, Saturn+ and Navigator keypads.</p> <table border="1" style="width: 100%; border-collapse: collapse;"> <tr> <td style="background-color: #FF00FF; color: white; text-align: center;">KPX+</td> <td>P126E xE to enable/disable an option as required</td> </tr> <tr> <td style="background-color: #00FF00; color: white; text-align: center;">NAVIGATOR</td> <td>P126E > enable/disable an option as required</td> </tr> <tr> <td style="background-color: #00BFFF; color: white; text-align: center;">SMS*</td> <td>P[MasterCode]E P[InstallerCode]E P120E 1E</td> </tr> </table> <p>1E KPX & SATURN. Enables double key PANIC. (Both PANIC Keys together) 2E KPX & SATURN. enables double key FIRE. (Both FIRE keys 1, 3, together) 3E KPX & SATURN. Enables double key MEDICAL (Both MEDICAL keys 4, 6, together) and enables MEDICAL on Navigator. 4E Enables Entry Chime in Day mode. Used to announce entry in Day mode. 5E Enable Chime in Home Mode. Used to announce entry in Home mode. 8E Disable One Digit At A Time Display. This allows Navigator keypads to immediately display numeric options.</p>	KPX+	P126E xE to enable/disable an option as required	NAVIGATOR	P126E > enable/disable an option as required	SMS*	P[MasterCode]E P[InstallerCode]E P120E 1E
KPX+	P126E xE to enable/disable an option as required						
NAVIGATOR	P126E > enable/disable an option as required						
SMS*	P[MasterCode]E P[InstallerCode]E P120E 1E						

P129E	1E	0k EOL resistors	OFF
	2E	1k EOL resistors	OFF
	3E	1.5k EOL resistors	OFF
	4E	2.2k EOL resistors	ON
	5E	3.3k EOL resistors	OFF
	6E	3.9k EOL resistors	OFF
	7E	4.7k EOL resistors	OFF
	8E	5.6k EOL resistors	OFF
	9E	6.8k EOL resistors	OFF
	10E	8.2k EOL resistors	OFF
	11E	10k EOL resistors	OFF
	12E	12k EOL resistors	OFF
	13E	22k EOL resistors	OFF

P129E	END OF LINE RESISTOR OPTIONS						
<p>PROGRAM MODE LEVEL Installer</p> <p>FACTORY DEFAULT 4E, 2.2k</p> <p>NOTES</p> <ul style="list-style-type: none"> • Only one option can be on. Turning an option on turns off another. • The EOL value selected applies to all zone inputs and the external tamper input, except the keyswitch input which is always 2K2. • The keyswitch input (if enabled) always uses a 2K2 resistor regardless of the global EOL resistor value set by P129E. <p>Also see P60E 2E, 3E, page 29.</p>	<p>The End Of Line Resistor value for all zones and the external tamper can be programmed with one of 13 different resistor values.</p> <p>This allows the panel to be easily retro-fitted into almost any existing installation.</p> <table border="1" style="width: 100%; border-collapse: collapse;"> <tr> <td style="background-color: #FF00FF; color: white; text-align: center;">KPX+</td> <td>P129E xE to select one option as required</td> </tr> <tr> <td style="background-color: #00FF00; color: white; text-align: center;">NAVIGATOR</td> <td>P129E > select one option as required</td> </tr> <tr> <td style="background-color: #00BFFF; color: white; text-align: center;">SMS*</td> <td>P[MasterCode]E P[InstallerCode]E P129E xE</td> </tr> </table>	KPX+	P129E xE to select one option as required	NAVIGATOR	P129E > select one option as required	SMS*	P[MasterCode]E P[InstallerCode]E P129E xE
KPX+	P129E xE to select one option as required						
NAVIGATOR	P129E > select one option as required						
SMS*	P[MasterCode]E P[InstallerCode]E P129E xE						

AUTO-TIME FEATURES

Auto-Time features provide a set of powerful automation and timer functions with simple to program options.

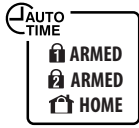

ARM or DISARM AUTOMATICALLY at pre-programmed times of day or day of the week. This feature can save a site manager many headaches and hours of travel time when staff forget to arm or disarm the system.

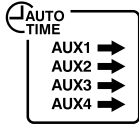

TURN OUTPUTS ON or OFF at pre-programmed times - every day, once a week, anytime. Automate doors, sprinkler systems, lights and more.



ENABLE/DISABLE USER CODES depending on the time of day or day of the week. Allows managers to grant users access to the system at selected times and deny after hours entry. This applies to keypad codes only, not radio keys or prox fobs.

EXAMPLE 1

AREA 1 to Auto Arm Monday to Friday at 6:30pm with warning beeps 10 minutes prior to the event.

The keypad will start a slow continuous beep at 6:20pm, then at 6:29pm the beeps change to a faster rate for the final minute.

TO SILENCE THE BEEPS during the warning period. Pressing any key on the keypad will stop the beeps on the keypad (and the Reset output) and then start again for the final minute with a slightly faster beep.

TO DELAY ARMING enter a valid user code on its own. (The user code must be assigned to an Area to work). This will turn off the warning beeps and the Auto Arm for 1 hour - when the warning process will start again.

Programming Steps

AutoTimer 1			
P350E	Minutes 0-59		30
P351E	Hours 0-23		18
P352E	Days (1=Sunday)	2, 3, 4, 5, 6	
P353E	1E	AREA 1 ARM	ON
	6E	KEYPAD Beeps	ON
	8E	Extend AutoTIME	ON
P390E	AutoTime warning		10

In this example, if reporting to a central station, the arming will be sent as User 91.

EXAMPLE 2

AUX1 turns on for one minute every Saturday at 8pm.

This could be used to turn on sprinklers, a pool or spa pump, lights or anything that can be triggered by a relay output. (Requires optional 106-013 Four Relay Board or 106-011 Expander).

Programming Steps

AutoTimer 2			
P355E	Minutes 0-59		00
P356E	Hours 0-23		20
P357E	Days (1=Sunday)	7	
P359E	6E	AUX1 PULSE	ON
P145E	AUX1 Pulse Time		60

TIP 1. The output can also be pulsed on (or toggled on/off) anytime using the 11 or 11# keypad commands. See page 15.*

TIP 2. For longer periods (up to a week), a pair of AutoTimers can be used - one to turn the AUX ON & the other to turn it OFF.

EXAMPLE 3

User Code 56 is programmed to work only on Monday-Friday between 7am to 5pm.

The user code will be disabled outside of these times. (Applies only to keypad codes. Radio keys and prox fobs will work anytime regardless.)

Programming Steps

Enable Extra Option 9E for user code 56 to enable the user code for use by AutoTime.

EXCLUDE+E toggles Extra Options mode. See page 19.	9E Enable user Code for AutoTime
P256E	User Code 56
	ON

AutoTimer 3 Enables the user code.

AutoTimer 3			
P360E	Minutes 0-59		00
P361E	Hours 0-23		07
P362E	Days (1=Sunday)	2, 3, 4, 5, 6	
P363E	4E	Code Enable	ON

AutoTimer 4 Disables the code.

AutoTimer 4			
P365E	Minutes 0-59		00
P366E	Hours 0-23		07
P367E	Days (1=Sunday)	2, 3, 4, 5, 6	
P368E	5E	Code Disable	ON



The power and flexibility of AutoTime means it has numerous programmable options which makes **NessComms software** the ideal programming tool.

The NessComms graphical user interface makes it easy to program complex options on your PC or laptop. Then simply connect and download.

NessComms makes it easy!



Auto-Time features depend on the onboard clock being set to the current time and date. If your DPlus panel has the optional 4G module the time is automatically set by the cellular network. If the panel is being used 'offline' without a SIM card then use options P340-P344E to set the clock, page 61.

Option No.	Description	Default	Note
P340E	REAL TIME CLOCK SET MINUTES	00	00–59 minutes
P341E	REAL TIME CLOCK SET HOURS	00	00–23 hours (00=midnight)
P342E	REAL TIME CLOCK SET DAY	01	01–31 days
P343E	REAL TIME CLOCK SET MONTH	01	01–12 months
P344E	REAL TIME CLOCK SET YEAR	09	00–63 (2000–2063)

P340 - P344E

PROGRAM MODE LEVEL

Installer, User

FACTORY DEFAULT

none

NOTES

- The onboard clock is automatically updated from your cellular network if the optional 106-985 Comms Module is fitted. Otherwise set the current time using program options P340E-P344E.
 - Real Time Clock memory is regularly saved to non-volatile memory and is retained on power down.
- You should always check the clock settings on power up and adjust the time and date if necessary.

REALTIME CLOCK PROGRAMMING

These options are used to program the time and date into the Realtime Clock (RTC).

KPX+	PxxxE [New Value] E
NAVIGATOR	PxxxE > [New Value] E
SMS*	P[MasterCode]E P[InstallerCode]E PxxxE [NewValue] E

P340E Real Time Clock minutes. Enter a value between 00 and 59. Default 00 minutes.

P341E Real Time Clock Hours. Enter a value between 00 and 23. Default 00 hours.

P342E Real Time Clock Day of the month. Enter a value between 01 and 31. Default 01, (1st day of the month). Ensure that the setting does not exceed the days in the current month. The panel does not cross-check this setting.

P343E Real Time Clock Month. Enter a value between 01 and 12. Default 01, (January).

P344E Real Time Clock Year. Enter a value between 00 and 63. (2000–2063). Default 09, (2009).

P390

PROGRAM MODE LEVEL

Installer

FACTORY DEFAULT

5 minutes

NOTES

This option sets the warning period for all AutoTimers.

RELATED OPTIONS

P353E 6E AutoTimer1, keypad beeps
 P358E 6E AutoTimer2, keypad beeps
 P363E 6E AutoTimer3, keypad beeps
 P368E 6E AutoTimer4, keypad beeps
 P373E 6E AutoTimer5, keypad beeps
 P378E 6E AutoTimer6, keypad beeps
 P383E 6E AutoTimer7, keypad beeps
 P388E 6E AutoTimer8, keypad beeps

AUTOTIME WARNING PERIOD

This option enables a keypad beep to warn that an AutoTime action is due to begin.

Set the minutes for the start of the warning period.

The Keypad Beeps option for the required timer/s must also be enabled.

KPX+	P39E [New Value] E
NAVIGATOR	P390E > [New Value] E
SMS*	P[MasterCode]E P[InstallerCode]E P390E [NewValue] E

The allowed range is 1 to 99 minutes.

P392E 1E

PROGRAM MODE LEVEL

Installer

FACTORY DEFAULT

1E OFF

ENABLE AUTOTIME USER CODES

Toggle the current setting for the ENABLING or DISABLING of USER Codes as set by the AutoTIMERS.

If the USER codes are currently DISABLED but the current AutoTIME period means that they should be ENABLED then use this option.

KPX+	P392E 1E to enable/disable the option as required
NAVIGATOR	P392E > enable/disable 1E as required
SMS*	P[MasterCode]E P[InstallerCode]E P392E 1E as required

* SMS programming and operation requires the optional 106-985 4G Module

P350 - P354E

PROGRAM MODE LEVEL

Installer

FACTORY DEFAULT

none

RELATED OPTIONS

P121E Enable AUX1 for AutoTimers
 P122E Enable AUX2 for AutoTimers
 P123E Enable AUX3 for AutoTimers
 P124E Enable AUX4 for AutoTimers
 P145E AUX1 Pulse Time.
 P146E AUX2 Pulse Time.
 P147E AUX3 Pulse Time.
 P148E AUX4 Pulse Time.
 P390E AutoTime Warning.
 P392E Enable AutoTime User Codes
 P202E - P256E Extra Option 9. Enable user codes for AutoTime.

NOTE 1. Do not use the same AutoTimer to enable and disable user codes. For example, use AutoTimer1 to set the Code Enable time and AutoTimer2 to set the Code Disable Time.

The user codes must also be enabled for AutoTime using Extra Options for user codes.

NOTE 2. If Open/Closing reports are enabled a Closing Extended report is sent to the control room.

NOTE 3. If Open/Closing reports are programmed, user Codes 91 to 98 are used to identify AutoTIME arming and disarming. AutoTime1 is code 91 then consecutively through to AutoTIME 8 is code 98.

NOTE 4. Note that each AutoTimer controls different AUX outputs.

NOTE 5. These instructions cover the programming of AutoTimer1. The programming for AutoTimers 2 to 8 is identical but with a different set of option numbers. See the Options Summary on page 78 for a full list of programming options for each AutoTimer.

HANDY HINT.

There are two ways to turn outputs on by AutoTimer - depending on how long the AUX output is to stay on.

1. If the ON period is less than 20 seconds then the Pulse Output option can be used to get timing periods measured in seconds. This method only requires one AutoTimer to be programmed.
2. For longer periods (up to a week), a pair of AutoTimers can be used - one to turn the AUX ON & the other to turn it OFF.

AUTOTIMER1 / AutoTimers 2-8 NOTE 5

STEP 1

Set the the Time and Day Of The Week at which AutoTimer1 will activate.

KPX+	PxxxE [New Value] E
NAVIGATOR	PxxxE > [New Value] E
SMS*	P[MasterCode]E P[InstallerCode]E PxxxE [NewValue] E

P350E AutoTimer1 Minutes. Enter a value between 00 and 59.

P351E AutoTimer1 Hours. Enter a value between 00 and 23. (00 = Midnight).

P352E AutoTimer1 Day. Enter values between 1 and 7. (1E=Sunday). If the AutoTimer event is intended to take place every day, then enable all days, 1E-7E.

STEP 2

Set the Actions which will take place on the Time and Day set above.

KPX+	PxxxE xE to enable/disable an option as required
NAVIGATOR	PxxxE > enable/disable an option as required
SMS*	P[MasterCode]E P[InstallerCode]E P392E 1E as required

P353E or P354E

1E-8E to turn an option ON or OFF. Multiple options can be selected.

TO ENABLE AUTO-ARMING

P353E 1E Area1 Arm. Arms Area1 at the time & day set by AutoTimer1.

P353E 2E Area2 Arm. Arms Area2 at the time & day set by AutoTimer1.

P353E 3E Home Arm. Arms Home Mode at the time & day set by AutoTimer1.

Note. Option 3E enables Home Arm for AutoTimers 1 to 6 but enables Day Mode Arm for AutoTimers 7 and 8.

TO ENABLE/DISABLE USER CODES BY AUTOTIMER NOTE 1

P353E 4E Code Enable. User Codes enabled for AutoTime become active from the time set above. CODE ENABLE/DISABLE allows a period to be set on selected days of the week during which selected user codes can be used. Outside this period the codes will not work.

P353E 5E Code Disable. User Codes enabled for AutoTime are disabled at the time set above.

TO ENABLE PRE-EVENT WARNING BEEPS

P353E 6E Keypad Beeps. Turn this option on to enable the AutoTimer Warning (continuous slow beeps). The keypad/s will beep to warn that this AutoTimer is about to begin. Keypad beeps begin xx minutes before the AutoTimer is due to start as set by option P390E.

1. To **silence the beeps** during the warning period. Pressing any key on the keypad will stop the beeps on the keypad (and the Reset output) and then start again for the final minute with a slightly faster beep.
2. To **delay the AutoTime event**, enter a valid user code on its own. (The user code must be assigned to an Area to work). This will turn off the warning beeps and the Auto Arm for 1 hour - when the warning process will start again.

P353E 7E Reset Output Beeps. If 6E is ON, then this option also beeps the RESET output for a much louder AutoTimer warning if required.

P353E 8E Enable AutoTimer Extension. This allows the AutoTIME Arming NOTE 2, Code Enable & Disable and the Aux3, Aux4 actions to be delayed by entering a USER code during the Warning period.

TO ENABLE AUTO-DISARMING FOR EACH AREA NOTE 3

P354E 1E Area1 Disarm. Disarms Area1 at the time & day set by AutoTimer1.

P354E 2E Area2 Disarm. Disarms Area2 at the time & day set by AutoTimer1.

P354E 3E Home Disarm. Disarms Home Mode at the time & day set by AutoTimer1.

P354E 4E [not used]

TO CONTROL OUTPUTS BY AUTOTIMER NOTE 4 & NOTE 5

These AUX actions will take place at the time & day set by AutoTimer1.

P354E 5E AUX1 Toggle. Changes the current state of the AUX1 output. If ON then it will turn OFF and if OFF will turn ON.

P354E 6E AUX1 Pulse. Turns on the AUX1 output for a time period set P145E.

P354E 7E AUX2 Toggle. Changes the current state of the AUX2 output. If ON then it will turn OFF and if OFF will turn ON.

P354E 8E AUX2 Pulse. Turns on the AUX2 output for a time period set P146E.

Note. AUX outputs must be enabled for control by AutoTimers at options P121E-P124E.

* SMS programming and operation requires the optional 106-985 4G Module

RADIO DEVICES OPERATION

ALARM: Any Ness radio device can operate on any zone. Hardwired zones continue to operate in parallel.

Radio Keys can also operate on radio zones for special purposes, but they should normally be used as Radio Codes.

Keyswitch input: A Radio Device programmed to Zone 8 will still work as an alarm even if the Zone 8 input operation has been changed to Keyswitch operation. The P60E 2E and 3E options only affect the Zone 8 terminal inputs.

VIBRATION: Radio device zone signals IGNORE the P30E–P38E vibration sensor settings.

TAMPER REPORT: Radio Device Tamper operation depends on the Armed State of the control panel.

RADIO TAMPER: causes the keypad to continuously beep and also to flash the RADIO, TAMPER and the ZONE (identifying the detector) lights. Pressing any key on the keypad or sending a TAMPER RESTORE will clear this warning.

LOW BATTERY REPORT: A low battery gives 10 beeps and flashes the RADIO & the BATTERY light. The ZONE light identifying the radio device is also ON. The flashing lights stop when any key on the keypad is pressed or a detector code with no low battery is received. Low Battery generates HISTORY and Communicator reports ONCE only (until the low battery is fixed and a restore report is received).

Supervision: If a zone has the P65E option ON and a radio code has been programmed for that zone, then the supervision is active. This means that the radio detector does not need to have its SUPER enabled (via header link) for the SUPERVISED timeout to occur. (Useful as an inactivity alarm). A zone supervision failure always flashes the identifying ZONE light and the RADIO light.

See pages 35 for more information about Zone Supervision.

RADIO INTERFACES

Connect the optional 106-462 Ness X-TWR Two Way Radio Interface or 100-200 Ness One Way Radio Interface. Connection to the control panel is via a 4 wire loom and plug supplied with the Radio Interface/s.

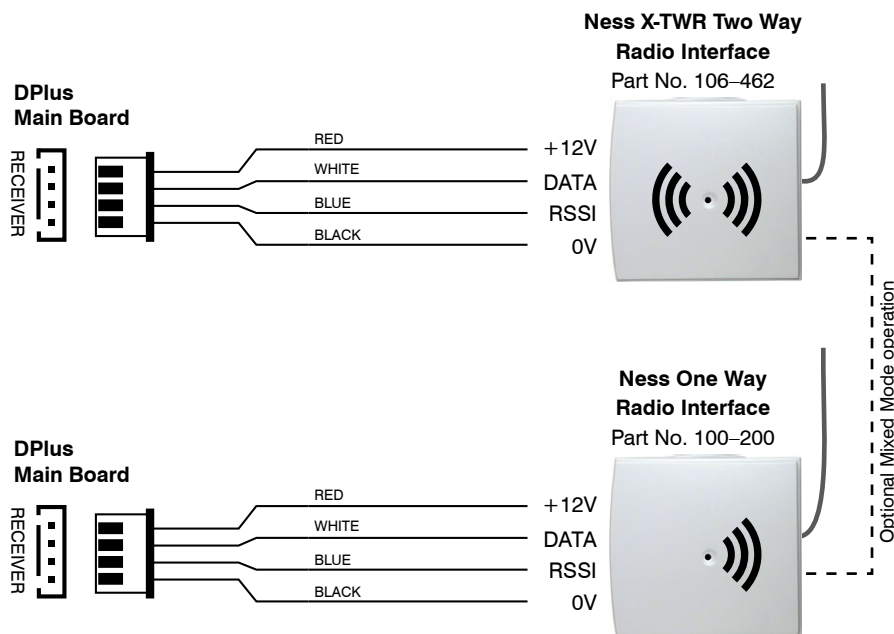

Connect one receiver at a time to the DPlus main board.

Mixed Mode Operation is supported, allowing both TWR and One Way devices on the same system. In this case, X-TWR plugs into DPlus and the One Way receiver plugs into the X-TWR. See 890-499 X-TWR Manual for details.

NOTES

- The Radio Interface should be installed outside the control panel to prevent interference from the control panel's electronics. If the Radio Interface must be installed inside a metal enclosure, the antenna wire should protrude outside the enclosure.
- In cases where radio reception needs to be improved, the Radio Interface can be installed up to 50 metres away from the control panel. Use 14/0.20 shielded cable or equivalent. The shield can either be connected to the EARTH connection or left unconnected. Leave the shield unconnected at the receiver end.
- For best performance, the antenna wire should be kept straight and not coiled, shortened or extended. An optional external antenna, 100-046 is available for the One Way Radio Interface only, for use in areas where the radio signal is marginal.

NOTES

- Signal strength of Radio Keys can be tested in USER PROGRAM Mode or INSTALLER PROGRAM Mode.
- Signal strength of all other Radio Devices is tested in INSTALLER PROGRAM Mode.
- PRESS 3E to test the signal strength of the selected transmitter ONLY. (Other devices will be ignored).
- PRESS 4E to test the signal strength of ANY Ness transmitter (including unprogrammed devices).

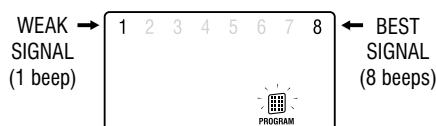

RADIO SIGNAL STRENGTH TEST

The Radio Signal Strength Test can be used to test the radio signal from any Ness radio device. The strength of the radio signal received is displayed on the zone lights 1 to 8 and beeped by the keypad.

The higher the number displayed (and beeped) the stronger the signal received.

TEST SEQUENCE:

- 1 Enter the program option for the radio device to be tested
For Radio Keys: options P201E–P256E. For Radio Devices, options P401E–P432E.
- 2 Press 3E
- 3 Trigger the radio device
 - One of zone lights 1 to 8 will turn ON to indicate the signal strength from the transmitter.
 - The Signal Strength display remains on until another command is entered.
 - To clear the display and re-test the transmitter, simply press 3E again (or 4E to test any other transmitter).

P401E – P432E

PROGRAM MODE LEVEL

Installer

FACTORY DEFAULT

No Radio Devices programmed.

NOTES

- Radio Device programming is done by 'learning' the code by radio.
- Radio Devices can be programmed and deleted by keypad or SMS.
- Some Ness Radio Devices send separate Alarm and Restore signals.
- For special purposes, radio zones can be also programmed to accept radio keys. In this case the zone can not be programmed to accept a radio device.
- Late model Ness Radio PIRs and Radio Reed Switches send Supervision signals.

SUPERVISION RELATED OPTIONS

P65E Supervised Radio Zones.

P66E Radio Supervision Alerts.

P67E Radio Supervision Time.

P75E 12E Radio Supervision Fail Report.

RADIO DEVICES

PROGRAM OPTIONS

The program option numbers are in the range P401E to P432E containing the zone number making them easy to remember.

Zone 1	P401E
Zone 2	P402E
Zone 3	P403E
Zone 4	P404E
Zone 5	P405E
Zone 6	P406E
Zone 7	P407E
Zone 8	P408E
Zone 9	P409E
... continues up to zone 32...	
Zone 31	P431E
Zone 32	P432E



TIP: To prevent conflicting radio signals when programming Radio Devices, disable each device once you have finished programming it. (Remove the battery).

Remember to enable all the devices when programming is completed.

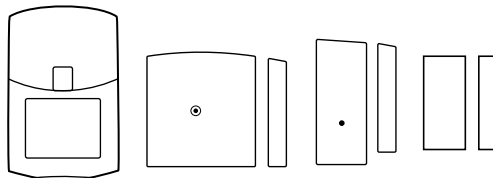

Instructions on this page apply to Ness One Way Radio devices.

ONE WAY RADIO

Hardware required: 100-200 Ness Radio Interface
Programming instructions: On this page

TWO WAY RADIO

Hardware required: 106-462 Ness X-TWR Radio Interface
Programming instructions: Separate 890-499 Ness X-TWR Manual

RADIO DEVICE PROGRAMMING

DPlus supports up to 32 wireless zones regardless of the number of hardwired zones fitted.

An optional Radio Interface is required.

PROGRAMMING RADIO DEVICES BY KEYPAD KPX+ NAVIGATOR

- 1 Select a zone using P401E – P432E.
If the zone already has a Radio Device programmed the KPX ARMED light will be ON. Or on Navigator keypad 'Radio Programmed' will display. Press 0E (or Delete Device) to delete.
- 2 KPX+ Press 1E (The OK icon indicates 'Ready To Learn')
NAVIGATOR Press
- 3 Send a Learn signal from the radio device by inserting the battery.
 - A. If the Radio Device is accepted, the OK icon will turn off, the ARMED light will turn on and 3 beeps will sound. On the Navigator keypad 'Radio Programmed' will display.
 - B. If an error beep sounds, the Radio Device is already assigned to another zone and must be cleared from that zone first.
 - C. If SUPERVISED SIGNALS have also been successfully recognised, the TAMPER light will turn ON.

EXAMPLE: To program a Radio PIR on zone 1:

P401E 1E (or press Program Device) Insert the battery in the Radio PIR

PROGRAMMING SEQUENCE – WITH RESTORALS

For Radio Reed Switches and Radio Smoke Detectors.

Go to Step 1 above, then:

- 1A KPX+ Press 2E (The MEM icon indicates this is a Restoring Radio Device.)
NAVIGATOR Press

Go to Step 2 above, then:

- 3 Send a Learn signal from the radio device:
Radio Reed Switch > Move the magnet towards the reed switch to send a signal.
Radio Smoke Detector > Insert the battery to send the learn signal.

PROGRAMMING RADIO DEVICES BY SMS SMS

Radio devices can be programmed remotely by SMS but of course somebody must be on site to initiate the learn signal on the radio device being programmed.

Example, to program a radio PIR on zone 1.

NOTE BEFORE. Make sure that no other radio devices send a signal during this sequence to prevent programming the wrong device.

The SMS string below enters program mode, selects zone 1, deletes any existing device, selects learn mode, then the panel will wait for 10 seconds for a learn signal. At this point you should insert the batteries in the radio PIR. Once the device is successfully programmed you will hear 3 beeps from the keypad. The panel will exit program mode on expiry of the 10 second learn window.

SMS P[MasterCode]E P[InstallerCode]E P401E 0E P401E 1E

DELETING A RADIO DEVICE

- 1 Use P401E to P432E to select the zone
- 2 KPX+ Press 0E to clear the device (3 beeps will sound)
NAVIGATOR Press
- 2 SMS add 0E after the option number. eg, to delete the radio device on zone 1, send P[MasterCode]E P[InstallerCode]E P401E 0E

P201E – P256E

PROGRAM MODE LEVEL

Installer

FACTORY DEFAULT

No Radio Codes, all code are keypad codes.

NOTES

- User Code 1 (Master Code) is always a Keypad Code.
- Radio Codes can be deleted by keypad in the case of a lost Radio Key.
- Radio Keys are assigned to User Codes, so that Open/Close reports are identified by user number when the control panel is base station monitored. (If Open/Close reports are enabled)
- Enable a User Code as a Radio Code in Extra Options - turn on 5E.

RELATED OPTIONS

P401E–P432E Programming Radio Devices.

TO DELETE A RADIO CODE

Any Radio Code can be deleted as required.

Delete a radio code if a) the radio key has been lost or b) prior to programming a new radio key to replace another.

Radio Codes are automatically deleted when the user code type is changed to keypad code or reader code.

EXAMPLE: To delete Radio Code 56. In Installer Program Mode: Press

KPX+ Press P256E 0E
NAVIGATOR Press P256E 

EXTRA OPTIONS MODE

To enable a User Code as a Radio Code go to EXTRA OPTIONS MODE and enable option 5E for that code. See steps 1 to 4 in Programming Sequence.

KPX+ Press EXCLUDE E to enter and exit Extra Options mode.

NAVIGATOR Press Extra Code Options to enter Extra Options mode. Press  to exit

PROGRAM OPTIONS

The program option numbers are in the range P201E to P256E (User Codes 01~56).

USER CODE	OPTION NO.	ENABLED AS A RADIO CODE?
1 (Master)	P201E	Keypad Only
2	P202E	
3	P203E	
4	P204E	
5	P205E	
6	P206E	
... continues up to user 56...		
56	P256E	

See the full list of programming options on page 73

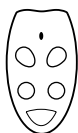

Instructions on this page apply to Ness One Way Radio devices.

ONE WAY RADIO

Hardware required: 100-200 Ness Radio Interface
 Programming instructions: On this page

TWO WAY RADIO

Hardware required: 106-462 Ness X-TWR Radio Interface
 Programming instructions: Separate 890-499 Ness X-TWR Manual

RADIO CODES

Each of the 56 User Codes, except for the Master Code, can be programmed to be Radio Codes. This allows up to 55 Ness Radio Keys to be used for Arming and Disarming of the panel.

An optional Radio Interface is required.

PROGRAMMING RADIO KEYS

Use the Extra Options programming mode to enable selected user codes as Radio Codes. When a user code is enabled as a Radio Code, its Keypad Code, (if any), is automatically deleted.

PROGRAMMING SEQUENCE:

- 1 In Installer Program Mode, enter the option number for the user code which will become a radio code. (Example, enter P256E for user code 56).
- 2 **KPX+** Press EXCLUDE E to enter Extra Options mode. (Exclude icon is on).
NAVIGATOR Press Extra Code Options.
- 3 **KPX+** Press 5E to enable that user code as a Radio Code. (Icon 5 is on).
NAVIGATOR Press 5 - Radio Code.
- 4 **KPX+** EXCLUDE E to exit Extra Options mode. (The Exclude icon is off).
NAVIGATOR Press  to exit the Extra Options screen.

- 5 **KPX+** Press 1E (The OK icon will turn ON to indicate ready to accept the Radio Key)
NAVIGATOR Press 

If a code is already programmed the OK icon will not turn on and a warning beep will sound. To clear the code, press 0E to clear existing codes then go back to step 5.

- 6 Press the OFF button on the Radio Key to be programmed
 If the Radio Key is accepted, the OK icon will turn off and 3 beeps will sound.
 If the OK icon stays on and a warning beep sounds, the Radio Key is already assigned to another User Code and must be cleared from that User Code first.

PROGRAMMING RADIO KEYS BY SMS SMS

Radio keys can be programmed remotely by SMS but of course somebody must be on site to initiate the learn signal on the radio key being programmed.

Example, to program a Ness RK4 Radio key as user 56.

The SMS string below enters program mode, selects user 56, enables the radio code, deletes any existing device, selects learn mode, then the panel will wait for 30 seconds for a learn signal. At this point you should press the OFF button on the radio key. Once the device is successfully programmed you will hear 3 beeps from the keypad. The panel will exit program mode on expiry of the 30 second learn window.

SMS P[MasterCode]E P[InstallerCode]E P256E XE5EXE 0E 1E

When the keypad displays READY TO RECEIVE / OK, press the OFF button on the radio key.

PROGRAMMING

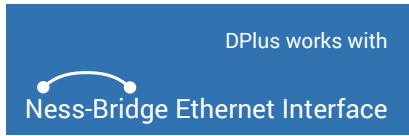

Option No.	Description	Default	
P199E	1E	Send Address	OFF
	2E	Send Time Stamp	OFF
	3E	Send Alarms	OFF
	4E	Send Warnings	OFF
	5E	Send Access Events	OFF
	6E	Zone Seal State	OFF
	7E	Send Test ASCII data	OFF
	8E	[not used]	OFF

P199E

PROGRAM MODE LEVEL

Installer

FACTORY DEFAULT

Options 1E-7E OFF - Serial data options disabled.

NOTES

The RS232 Serial data is output at 9600 baud, 8 data bits, no parity, 1 stop bit

SERIAL OUTPUT OPTIONS

NESS-BRIDGE

To enable the optional **NESS-BRIDGE ethernet interface** turn on options P199E 1E

FOR DEVELOPERS

Enable various options for two way serial data communications via the onboard RS232 SERIAL port allowing high level interfacing with various external devices/controllers/dataloggers and other.

Messages are in ASCII format. The Ness serial protocol is available on request.

KPX+	P199E xE to select one option as required
NAVIGATOR	P199E > select one option as required
SMS*	P[MasterCode]E P[InstallerCode]E P199E xE

1E ON: Send Address. The address is the last digit of Acc No.2 (P73E).

2E ON: Send Time Stamp.

3E ON: Send Alarms.

4E ON: Send Warnings.

5E ON: Send Access Events.

6E ON: Send Zone Seal State.

7E ON: Send test ASCII string. Sends test data periodically, used for testing the serial port.

* SMS programming and operation requires the optional 106-985 4G Module

WIRING A SINGLE READER

P301E 1E is OFF (Reader addresses not used)

Connect only 1 reader.

In this mode the panel is compatible with the Ness 101-014 Ness Ultraprox Weigand Reader.

i Recommended cable is twisted 3 pair shielded cable with only one end of the shield connected to ground. For cable runs exceeding 75m use the Ness Weigand data repeater.

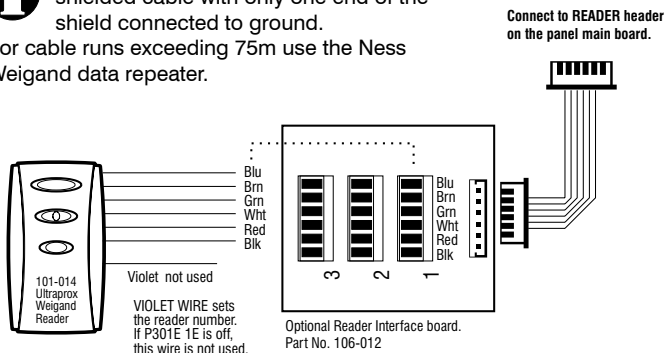

WIRING A DOOR STRIKE

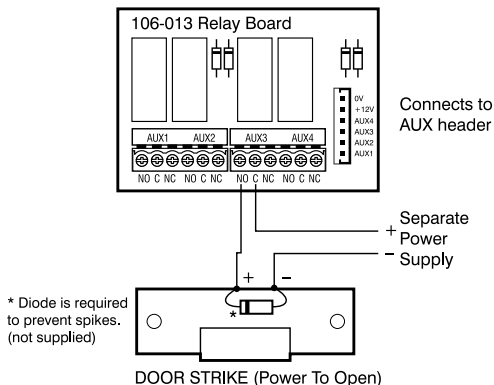

WIRING MULTIPLE READERS

P301E 1E is ON (Use Reader addresses)

When multiple readers are used, the panel needs to identify the individual readers.

The 101-014 Ness Ultraprox Weigand Readers can be addressed as Reader 1, 2 or 3 by connecting the Violet wire to an appropriate terminal.

You can setup 3 x 101-014 readers with individual addresses or setup one or more readers with the same address.

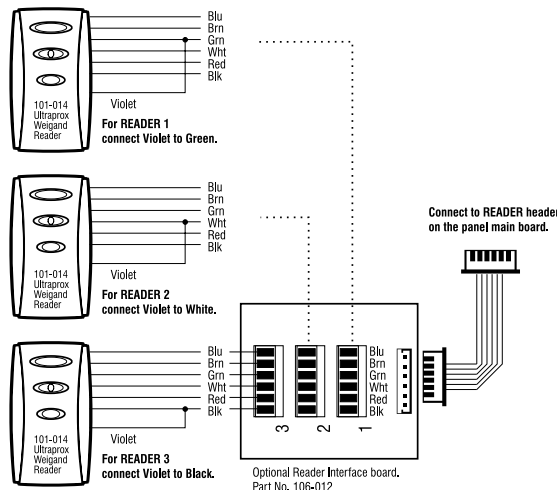

REQUEST TO EXIT (REX) USING A KEYPAD CODE

Codes selected for Code Only Arming can be used as REX codes for access control functions. That is, the code can operate an output instead of arming/disarming the panel.

There are two conditions needed to make the code operate as a REX code - It is assigned to CODE ONLY ARM and it is not assigned to either Area 1 or Area 2.

The first digit of the user code determines which AUX output is operated by the REX code. That is, a REX code in the format 1xxx operates AUX1, 2xxx operates AUX2 and 3xxx operates AUX3.

Notes:

1. Reader 1 can also use codes starting with 4-9 if only one exit point is used.
2. Set P318E, P328E, P338E options to select appropriate AUX outputs.
3. Set corresponding P121E, P122E, P123E, P124E options to 8E.

Setup Example:

- User Codes 1555, 2555, 3555 are programmed to be Code Only Arm and are not assigned to Area 1 or Area 2.
- P318E 1E, P328 2E, P338 3E are programmed to set reader output to selected Aux output.
- P121E 8E, P122E 8E, P123E 8E are programmed to set AUX outputs to reader.

Operation Example:

- Code 1555 activates door associated with AUX1 (READER 1).
- Code 2555 activates door associated with AUX2 (READER 2).
- Code 3555 activates door associated with AUX3 (READER 3).

P300E

PROGRAM MODE LEVEL
Installer

Option No. Description

P300E	DEFAULT ALL ACCESS CONTROL OPTIONS
-------	------------------------------------

DEFAULT ALL ACCESS CONTROL OPTIONS

Enter P300E in Installer program mode to return all access control programs to factory default values.



RELATED OPTIONS

P301E 2E Allow arming with a double read
P301E 3E Allow arming with a single read and pushbutton.

P301E 4E Allow disarming, (single read).

Separate options for arming & disarming allows 'arm only' permission to be granted if required.

P121E 8E, P122E 8E, P123E 8E and P124E 8E to enable readers to operate AUX outputs.

P301E 1E Use Reader Addresses allows up to 3 Ness 101-014 Ultraprox Readers to be used with individual addresses.

P318E - P338E Assign readers to AUX outputs.

i If connecting multiple readers, the option to enable multiple readers (P301E 1E) should be turned on *before* programming any access cards. (Enabling P301E 1E erases existing card programming).

i If P301E 3E is enabled, a momentary push button can be wired to zone 8 as shown.

For example, this option allows the reader output to operate a door lock during the day by presenting your card. Then at the end of the day press the push button within 5 seconds of presenting the card and the panel will arm.

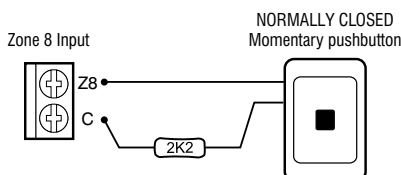
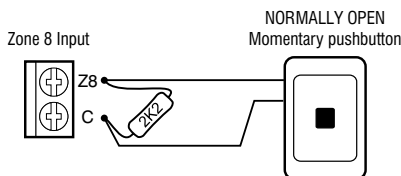

* SMS programming and operation requires the optional 106-985 4G Module

PROGRAMMING ACCESS CARDS

If the panel has 1, 2 or 3 Weigand proximity readers connected up to 55 of the user codes can be programmed as Reader Codes. This allows arming/disarming by access card and operation of AUX outputs to open electric door strikes.

Use the Extra Options programming mode to enable selected user codes to Readers 1, 2 or 3. When a user code is enabled as a Reader Code, its Keypad Code, (if any), is automatically deleted. A user code enabled as a Reader Code cannot also be a Keypad Code or Radio Code.

PROGRAMMING SEQUENCE:

- 1 In Installer Program Mode, enter the option number for the user code to be programmed. (P202E–P256E).
- 2 **KPX+** Press EXCLUDE E to enter Extra Options mode. (Exclude icon is on).
NAVIGATOR Press Extra Code Options.
- 3 **KPX+** and **NAVIGATOR** Press 6E, 7E or 8E to assign the user code to Reader 1, 2 or 3, or all three.
- 4 **KPX+** EXCLUDE E to exit Extra Options mode. (The Exclude icon is off).
NAVIGATOR Press to exit the Extra Options screen.
- 5 **KPX+** Press 1E (The OK icon will turn ON to indicate ready to accept the access card)
NAVIGATOR Press

If a code is already programmed the OK icon will not turn on and a warning beep will sound. To clear the code, press 0E to clear existing codes then go back to step 5.

- 6 Present a valid access card to the reader.

If the card or fob is of a valid type, the reader's orange light will turn on.

If the card is accepted, the keypad OK icon will turn off and 3 beeps will sound.

If the OK icon stays on and a warning beep sounds, the access card is already assigned to another user code and must be cleared from that code first.

PROGRAMMING ACCESS CARDS BY SMS SMS

Access cards can be programmed remotely by SMS as long as a person is on site to present the card to the reader for programming.

Example, to program an access card as user 55.

The SMS string below enters program mode, selects user 55, assigns the code to readers 1,2 and 3, deletes any existing code, selects learn mode, then the panel will wait for 30 seconds for a card to be enrolled. At this point you should present the card to a reader. Once the card is successfully programmed you will hear 3 beeps from the keypad. The panel will exit program mode on expiry of the 30 second learn window.

SMS*	P[MasterCode]E P[InstallerCode]E P255E XE6E7E8EXE 0E 1E
-------------	---

When the keypad displays READY TO RECEIVE / OK, present the card to a reader.

Option No.	Description	Default	
P301E	1E	Use reader addresses	OFF
	2E	Arm with double read	ON
	3E	Arm with single read and pushbutton	OFF
	4E	Disarm with access card	ON
	5E	REX Input 1 (Zone 5 input)	OFF
	6E	REX Input 2 (Zone 6 input)	OFF
	7E	REX Input 3 (Zone 7 input)	OFF
	8E	Strobe Flash on Arm/Disarm by Reader	ON

P301E	ACCESS CONTROL OPTIONS 1E - 8E						
PROGRAM MODE LEVEL Installer mode	Enable or disable P301E 1E to 8E as required. Only one option can be on. <table border="1" style="margin-top: 10px;"> <tr> <td style="background-color: #ff00ff; color: white;">KPX+</td> <td>P301E 1E - 8E to enable/disable the option as required</td> </tr> <tr> <td style="background-color: #00ff00; color: white;">NAVIGATOR</td> <td>P301E > enable/disable 1E - 8E as required</td> </tr> <tr> <td style="background-color: #00bfff; color: white;">SMS*</td> <td>P[MasterCode]E P[InstallerCode]E P301E [1E -8E] as required</td> </tr> </table>	KPX+	P301E 1E - 8E to enable/disable the option as required	NAVIGATOR	P301E > enable/disable 1E - 8E as required	SMS*	P[MasterCode]E P[InstallerCode]E P301E [1E -8E] as required
KPX+	P301E 1E - 8E to enable/disable the option as required						
NAVIGATOR	P301E > enable/disable 1E - 8E as required						
SMS*	P[MasterCode]E P[InstallerCode]E P301E [1E -8E] as required						
P301E 1E	USE READER ADDRESSES						
FACTORY DEFAULT OFF (Use one reader). NOTES When using multiple readers, this option must be enabled before programming any access cards, (to avoid losing card programming when the option is enabled).	If ON then all readers connected to the DPlus must have set addresses of 1, 2 or 3. The data is then sent in an extended format that includes the reader address. (Use up to three Ness prox readers). The reader's address is determined the connection of the violet wire. See the wiring diagram on page 67). If this option is off, one standard Weigand 26bit reader can be used.						
P301E 2E	ARM WITH DOUBLE READ						
FACTORY DEFAULT ON	When this option is enabled the panel will arm if the same valid access card is presented to a reader twice within 5 seconds.						
P301E 3E	ARM WITH SINGLE READ AND PUSHBUTTON						
FACTORY DEFAULT OFF NOTES <ul style="list-style-type: none"> Connect a pushbutton to Zone 8. This option automatically disables zone 8 as an alarm zone 	When this option is enabled the panel will arm if a valid access card is presented to a reader once and zone 8 is unsealed momentarily within 5 seconds. This option can be used to prevent accidental arming or disarming by access card.						
P301E 4E	DISARM WITH ACCESS CARD						
FACTORY DEFAULT ON	When this option is enabled a valid access card will disarm the panel.						
P301E 5E–7E	REQUEST TO EXIT (REX) INPUTS						
FACTORY DEFAULT OFF NOTES <ul style="list-style-type: none"> When one of these options is enabled, that zone is automatically disabled as an alarm zone. The zone must reseal before another Request To Exit can occur. i.e, If the zone is left unsealed, the door will not be left unlocked. RELATED OPTIONS P37E, P38E Long Response Zones P318E, P328E, P338E, P121E–P124E Programming of Readers to Aux outputs.	These options convert zones 5, 6 and 7 into Request To Exit (REX) inputs for access control, allowing for push button door exit. Connect a N/C or N/O pushbutton to either open circuit or short circuit the zone resistor. The REX zones can also be programmed as Long Response Zones (P37E, P38E) to prevent accidental door opening, the REX button must be pressed and held for 1sec or 3sec, as programmed. P301E 5E enables Zone 5 to trigger the AUX outputs assigned to Reader1. P301E 6E enables Zone 6 to trigger the AUX outputs assigned to Reader2. P301E 7E enables Zone 7 to trigger the AUX outputs assigned to Reader3.						
P301E 8E	STROBE FLASH ON ARM/DISARM BY READER						
Factory Default ON	This option enables strobe flash when arming and disarming by Reader.						

* SMS programming and operation requires the optional 106-985 4G Module

Option No.	Description	ZONES 1-8								ZONES 9-32 IF FITTED							
		1	2	3	4	5	6	7	8	9	10	11	31	31	32
P303E	DOTL ZONES																

P303E	DOOR OPEN TOO LONG (DOTL) ZONES						
<p>PROGRAM MODE LEVEL Installer</p> <p>FACTORY DEFAULT All OFF: No DOTL zones.</p> <p>NOTES Zones can be assigned as DOTL zones in addition to normal alarm functions. Therefore, DOTL zones can operate as alarm zones when armed and DOTL zones when disarmed. (Day Zone programming still applies).</p> <p>RELATED OPTIONS P121E 7E DOTL Alarms to AUX1 P122E 7E DOTL Alarms to AUX1 P305E Misc DOTL options P304E DOTL Time</p> <p>KPX+ PRO TIP When selecting zones, MEMORY E selects all, 0 E deselects all.</p>	<p>This selects the zones that will generate a DOTL alert if the zone is unsealed for longer than the time set by P304E.</p> <table border="1" style="width: 100%;"> <tr> <td style="background-color: #FF00FF; color: white;">KPX+</td> <td>P303E [Zone Number] E to enable/disable zones</td> </tr> <tr> <td style="background-color: #00FF00; color: white;">NAVIGATOR</td> <td>P303E > Select zones</td> </tr> <tr> <td style="background-color: #00BFFF; color: white;">SMS*</td> <td>P[MasterCode]E P[InstallerCode]E P303E [Zone Number] E</td> </tr> </table>	KPX+	P303E [Zone Number] E to enable/disable zones	NAVIGATOR	P303E > Select zones	SMS*	P[MasterCode]E P[InstallerCode]E P303E [Zone Number] E
KPX+	P303E [Zone Number] E to enable/disable zones						
NAVIGATOR	P303E > Select zones						
SMS*	P[MasterCode]E P[InstallerCode]E P303E [Zone Number] E						

Option No.	Description	Default	Note
P304E	DOTL TIMER	20	01-99 seconds

P304E	DOTL TIMER						
<p>PROGRAM MODE LEVEL Installer</p> <p>FACTORY DEFAULT 20 seconds</p> <p>RELATED OPTIONS P303E DOTL Zones P121E 7E DOTL Alarms to AUX1 P122E 7E DOTL Alarms to AUX1 P305E Misc DOTL options</p>	<p>Sets the delay time in seconds before a DOTL zone generates a DOTL alert. Enter a value between 01 and 99.</p> <table border="1" style="width: 100%;"> <tr> <td style="background-color: #FF00FF; color: white;">KPX+</td> <td>P304E [New Value] E</td> </tr> <tr> <td style="background-color: #00FF00; color: white;">NAVIGATOR</td> <td>P304E > [New Value] E</td> </tr> <tr> <td style="background-color: #00BFFF; color: white;">SMS*</td> <td>P[MasterCode]E P[InstallerCode]E P304E [NewValue] E</td> </tr> </table>	KPX+	P304E [New Value] E	NAVIGATOR	P304E > [New Value] E	SMS*	P[MasterCode]E P[InstallerCode]E P304E [NewValue] E
KPX+	P304E [New Value] E						
NAVIGATOR	P304E > [New Value] E						
SMS*	P[MasterCode]E P[InstallerCode]E P304E [NewValue] E						

* SMS programming and operation requires the optional 106-985 4G Module

Option No.	Description	Default	
P305E	1E	DOTL output LATCHES	OFF
	2E	DOTL outputs to Output Expander	OFF
	3E	DOTL Timer in Minutes	OFF
	4E	DOTL Timer in Hours	OFF
	5E	DOTL zone flashes on keypad	OFF
	6E	[not used]	OFF
	7E	[not used]	OFF
	8E	[not used]	OFF

P305E	ACCESS CONTROL OPTIONS 1E - 5E						
PROGRAM MODE LEVEL Installer mode FACTORY DEFAULT All OFF	Enable or disable P305E 1E to 5E as required. <table border="1" style="margin-top: 10px;"> <tr> <td style="background-color: #ff00ff; color: white;">KPX+</td> <td>P305E 1E - 5E to enable/disable the option as required</td> </tr> <tr> <td style="background-color: #00ff00; color: white;">NAVIGATOR</td> <td>P305E > enable/disable 1E - 5E as required</td> </tr> <tr> <td style="background-color: #00bfff; color: white;">SMS*</td> <td>P[MasterCode]E P[InstallerCode]E P305E [1E -5E] as required</td> </tr> </table>	KPX+	P305E 1E - 5E to enable/disable the option as required	NAVIGATOR	P305E > enable/disable 1E - 5E as required	SMS*	P[MasterCode]E P[InstallerCode]E P305E [1E -5E] as required
KPX+	P305E 1E - 5E to enable/disable the option as required						
NAVIGATOR	P305E > enable/disable 1E - 5E as required						
SMS*	P[MasterCode]E P[InstallerCode]E P305E [1E -5E] as required						
P305E 1E	DOTL OUTPUT LATCHES						
RELATED OPTIONS P121E 7E DOTL Alerts to Aux1. P122E 7E DOTL Alerts to Aux2.	With this option on, DOTL alerts will either follow the sealed/unsealed state of DOTL zones or latch the Aux output/s which have been programmed for DOTL alerts.						
P305E 2E	DOTL ALERTS TO OUTPUT EXPANDER						
RELATED OPTIONS P117E 1E Enable Output Expander	With this option on, DOTL alerts will be sent to the optional Output Expander on the same output number as the DOTL zone number. P305E 1E settings apply.						
P305E 3E	DOTL TIMER IN MINUTES						
RELATED OPTIONS P304E DOTL Timer	With this option ON, the P304E timer counts in minutes rather than seconds to give the option for longer DOTL times.						
P305E 4E	DOTL TIMER IN HOURS						
RELATED OPTIONS P304E DOTL Timer	With this option ON, the P304E timer counts in hours rather than seconds to give the option for extra long DOTL times.						
P305E 5E	DOTL ALERTS TO KEYPAD						
	With this option on, DOTL alerts will SLOWLY flash the corresponding zone light on the keypad. P305E 1E settings apply.						

Option No.	Description	Default	Note
P319E	ULTRAPROX READER 1 OUTPUT TIME	5	01-24 seconds
P329E	ULTRAPROX READER 2 OUTPUT TIME	5	01-24 seconds
P339E	ULTRAPROX READER 3 OUTPUT TIME	5	01-24 seconds

P319E, P329E, P339E	READERS 1-3 OUTPUT TIME						
PROGRAM MODE LEVEL Installer FACTORY DEFAULT 5 seconds RELATED OPTIONS P318E, P328E, P338E	Sets the time that the outputs selected by P318E, P328E and P338E are ON. Range 1-24 seconds. <table border="1" style="margin-top: 10px;"> <tr> <td style="background-color: #ff00ff; color: white;">KPX+</td> <td>P304E [New Value] E</td> </tr> <tr> <td style="background-color: #00ff00; color: white;">NAVIGATOR</td> <td>P304E > [New Value] E</td> </tr> <tr> <td style="background-color: #00bfff; color: white;">SMS*</td> <td>P[MasterCode]E P[InstallerCode]E P304E [NewValue] E</td> </tr> </table>	KPX+	P304E [New Value] E	NAVIGATOR	P304E > [New Value] E	SMS*	P[MasterCode]E P[InstallerCode]E P304E [NewValue] E
KPX+	P304E [New Value] E						
NAVIGATOR	P304E > [New Value] E						
SMS*	P[MasterCode]E P[InstallerCode]E P304E [NewValue] E						

* SMS programming and operation requires the optional 106-985 4G Module

Option No.	Description	Default	
P318E	1E	Ultraprox Reader1 to AUX1	OFF
	2E	Ultraprox Reader1 to AUX2	OFF
	3E	Ultraprox Reader1 to AUX3	OFF
	4E	Ultraprox Reader1 to AUX4	OFF
	5E	Ultraprox Reader1 to AUX5	OFF
	6E	Ultraprox Reader1 to AUX6	OFF
	7E	Ultraprox Reader1 to AUX7	OFF
	8E	Ultraprox Reader1 to AUX8	OFF
P328E	1E	Ultraprox Reader2 to AUX1	OFF
	2E	Ultraprox Reader2 to AUX2	OFF
	3E	Ultraprox Reader2 to AUX3	OFF
	4E	Ultraprox Reader2 to AUX4	OFF
	5E	Ultraprox Reader2 to AUX5	OFF
	6E	Ultraprox Reader2 to AUX6	OFF
	7E	Ultraprox Reader2 to AUX7	OFF
	8E	Ultraprox Reader2 to AUX8	OFF
P338E	1E	Ultraprox Reader3 to AUX1	OFF
	2E	Ultraprox Reader3 to AUX2	OFF
	3E	Ultraprox Reader3 to AUX3	OFF
	4E	Ultraprox Reader3 to AUX4	OFF
	5E	Ultraprox Reader3 to AUX5	OFF
	6E	Ultraprox Reader3 to AUX6	OFF
	7E	Ultraprox Reader3 to AUX7	OFF
	8E	Ultraprox Reader3 to AUX8	OFF

P318E, P328E, P338E	READERS 1-3 TO AUX OUTPUTS 1-8						
<p>PROGRAM MODE LEVEL Installer mode</p> <p>FACTORY DEFAULT All OFF</p>	<p>Enable or disable P318E, P328E, P338E, 1E to 8E as required.</p> <p>These options give the flexibility of assigning any access reader to any Aux output for operating door strikes, magnetic locks, etc. Readers can be assigned to multiple outputs. Always use an external relay board (101-283) on each Aux output on the output expander/s if connecting devices which draw more than 100mA.</p> <table border="1"> <tr> <td>KPX+</td> <td>PxxxE 1E - 8E to enable/disable the option as required</td> </tr> <tr> <td>NAVIGATOR</td> <td>PxxxE > enable/disable 1E - 8E as required</td> </tr> <tr> <td>SMS*</td> <td>P[MasterCode]E P[InstallerCode]E PxxxE [1E -8E] as required</td> </tr> </table>	KPX+	PxxxE 1E - 8E to enable/disable the option as required	NAVIGATOR	PxxxE > enable/disable 1E - 8E as required	SMS*	P[MasterCode]E P[InstallerCode]E PxxxE [1E -8E] as required
KPX+	PxxxE 1E - 8E to enable/disable the option as required						
NAVIGATOR	PxxxE > enable/disable 1E - 8E as required						
SMS*	P[MasterCode]E P[InstallerCode]E PxxxE [1E -8E] as required						
P318E 1E-8E	READER 1 TO AUX OUTPUTS						
<p>RELATED OPTIONS P121E 8E, P122E 8E, P123E 8E, P124E 8E, P151E 7E, P152E 7E, P153E 7E, P154E 7E, P319E, P329E, P339E</p>	Enable options 1-8 as required to assign Reader 1 to Aux outputs as per the table above.						
P328E 1E-8E	READER 2 TO AUX OUTPUTS						
<p>RELATED OPTIONS P121E 8E, P122E 8E, P123E 8E, P124E 8E, P151E 7E, P152E 7E, P153E 7E, P154E 7E, P319E, P329E, P339E</p>	Enable options 1-8 as required to assign Reader 2 to Aux outputs as per the table above.						
P338E 1E-8E	READER 3 TO AUX OUTPUTS						
<p>RELATED OPTIONS P121E 8E, P122E 8E, P123E 8E, P124E 8E, P151E 7E, P152E 7E, P153E 7E, P154E 7E, P319E, P329E, P339E</p>	Enable options 1-8 as required to assign Reader 3 to Aux outputs as per the table above.						

* SMS programming and operation requires the optional 106-985 4G Module



PROGRAMMING OPTIONS TABLE

Summary of all program options for Panel & Comms. Also refer to the separate **DPlus Comms Manual**

USER CODE OPTIONS TABLE

KPX+ EXCLUDE+E toggles Extra Options mode. **NAVIGATOR** Press Extra Code Options. (Installer Program mode only)

USER CODE U	OPTION NO.	KEYPAD PIN	PAGE 18-19				Page 65	Page 67			Page 62
			1E AREA 1 Code	2E AREA 2 Code	3E ARM ONLY	4E "CODE ONLY" ARM (REX CODE)	5E RADIO Code	6E Reader 1 Code	7E Reader 2 Code	8E Reader 3 Code	9E Enable for AutoTime
1 (Master)	P201E	123	ON	ON							
2	P202E		ON								
3	P203E		ON								
4	P204E		ON								
5	P205E		ON								
6	P206E		ON								
7	P207E		ON								
8	P208E		ON								
9	P209E		ON								
10	P210E		ON								
11	P211E		ON								
12	P212E		ON								
13	P213E		ON								
14	P214E		ON								
15	P215E		ON								
16	P216E		ON								
17	P217E		ON								
18	P218E		ON								
19	P219E		ON								
20	P220E		ON								
21	P221E		ON								
22	P222E		ON								
23	P223E		ON								
24	P224E		ON								
25	P225E		ON								
26	P226E		ON								
27	P227E		ON								
28	P228E		ON								
29	P229E		ON								
30	P230E		ON								
31	P231E		ON								
32	P232E		ON								
33	P233E		ON								
34	P234E		ON								
35	P235E		ON								
36	P236E		ON								
37	P237E		ON								
38	P238E		ON								
39	P239E		ON								
40	P240E		ON								
41	P241E		ON								
42	P242E		ON								
43	P243E		ON								
44	P244E		ON								
45	P245E		ON								
46	P246E		ON								
47	P247E		ON								
48	P248E		ON								
49	P249E		ON								
50	P250E		ON								
51	P251E		ON								
52	P252E		ON								
53	P253E		ON								
54	P254E		ON								
55	P255E		ON								
56	P256E		ON								



PROGRAMMING OPTIONS TABLE

Summary of all program options for Panel & Comms.
Also refer to the separate **DPlus Comms Manual**

OPTION	DESCRIPTION	DEFAULT	PAGE
P01E	OPTIONS FOR OPTIONAL R16 REMOTE EXPANDER		20
5E	Remote Panel Tamper		
13E	Remote Panel Low Battery	OFF	
14E	Remote Panel Mains Fail	OFF	
15E	Remote Panel Comms Fail	OFF	
P02E	Remote Comms Key	1234	
P03E	Remote Comms Count - Rolling Code	5678	
P26E U	ENTRY DELAY Time 1	20 sec	21
P27E U	Entry Delay Time 2	6=60 sec	
P28E U	EXIT DELAY Time	60 sec	
P29E	SIREN RESET Time	5 min	
P30E	Normal Zone Sensitivity	all zones	22
P31E-36E	Vibration Sensitivity, High-Low	none	
P37E	Long Response Zones - 1 second	none	
P38E	Long Response Zones - 3 seconds	none	
P39E	Double Trigger zones	none	23
P40E	Instant zones	zones 3+	
P41E	ENTRY DELAY 1 zones	Zone 1	24
P42E	HANDOVER zones	Zone 2	
P43E	Entry Delay 2 zones	none	
P44E	Lockout zones (RESET output)	All zones	
P45E	AREA 1 zones	All zones	
P46E	AREA 2 zones	none	26
P51E	HOME MODE zones	none	
* See page 25 for information on Area operation, Home mode & Temporary Day Zones			
P52E	24hr zones	none	26
P53E	Day Mode zones	none	
P54E	RESET output zones	All zones	27
P55E	STROBE zones	All zones	
P56E	Keypad Sonalert zones	All zones	
P57E	SIREN zones	All zones	28
P58E	Aux1 / Aux3 zones	none	
P59E	Aux2 / Aux4 zones	none	
P60E	1E Entry Beeps	ON	29-30
	2E Keyswitch Home/Disarm	OFF	
	3E Keyswitch Arm/Disarm	OFF	
	4E Tamper Siren lockout	ON	
	5E Duress to RESET output	OFF	
	6E Auto Exclude zones	ON	
	7E Auto keypad display off	OFF	
	8E Delayed Aux3, Aux4 outputs	OFF	

U Options marked "u" can be programmed in User Program Mode
All options can be programmed in Installer Program Mode

- Panel programming options - ORANGE
- SMS SMS related options - BLUE (See the Comms Manual)
- CS CENTRAL STATION reporting options - GREEN

*SMS & Central Station reporting requires the optional 106-985 4G Module

OPTION	DESCRIPTION	DEFAULT	PAGE
P61E	1E Tamper to RESET output	ON	31
	2E Tamper to STROBE output	ON	
	3E Tamper to Keypad Sonalert	ON	
	4E Tamper to SIREN output	ON	
	5E Keypad Panic to RESET output	ON	
	6E Keypad Panic to STROBE output	ON	
	7E Keypad Panic to Sonalert	ON	
	8E Keypad Panic to SIREN output	ON	
P62E	1E Shortcut Memory display	ON	32
	2E Shortcut Zone Exclude	ON	
	3E Shortcut Home Mode	ON	
	4E Shortcut Keypad Panic	OFF	
	5E Shortcut Area1 Arming	ON	
	6E Shortcut Area2 Arming	OFF	
	7E Brief warning on Auto Exclude	ON	
	8E Exit Time x10	OFF	
P63E	1E Home Mode alarms to RESET output	ON	33
	2E Home Mode alarms to STROBE	ON	
	3E Home Mode alarms to SONALERT	ON	
	4E Home Mode alarms to SIREN	OFF	
	5E Day Mode to RESET output	OFF	
	6E Day Mode to STROBE	OFF	
	7E Day Mode KP SONALERT (Chime KPX)	ON	
	8E Day Mode to SIREN	OFF	
P64E	1E Brief Home Mode Alarm	OFF	33-34
	2E Brief Day Alarm	OFF	
	3E Home zones Entry Delay2	ON	
	4E Radio Key SIREN CHIRPS	OFF	
	5E [not used]	OFF	
	6E Strobe Flash on Home arm by radio	OFF	
	7E [not used]	OFF	
	8E [not used]	OFF	
P65E	Supervised zones	NONE	35
P66E	1E Zone Supervision alarm to RESET o/p	OFF	36
	2E Zone Supervision alarm to STROBE	OFF	
	3E Zone Supervision alarm to SONALERT	OFF	
	4E Zone Supervision alarm to SIREN	OFF	
	5E Enable WIRED ZONE supervision	OFF	
	6E [not used]	OFF	
	7E Zone Supervision speedup x 6	OFF	
	8E Zone Supervision speedup x10	OFF	
P67E	Zone Supervision Time	24 (hours)	37
P68E	1E Double Press Radio Panic	OFF	38-39
	2E Auto Re-Arm	OFF	
	3E Long Radio Message	ON	
	4E "OK/READY" Display	OFF	
	5E Radio Arming "unsealed" warning	OFF	
	6E 24hr Zone Fire Siren sound	OFF	
	7E Single Shot strobe on Arm by R/Key	OFF	
	8E Quiet chirps on radio Arm/Disarm	OFF	

OPTION	DESCRIPTION	DEFAULT	PAGE	
P69E	1E	Flash strobe on medical alarm	OFF	40
	2E	[not used]	OFF	
	3E	Quiet Home Mode Siren	OFF	
	4E	6 beeps on Arming	OFF	
	5E	Home arm by radio key ON/OFF	OFF	
	6E	Disable Mains Fail Alarm	OFF	
	7E	Exit BEEPS - Full Arm	OFF	
	8E	Exit BEEPS - Home Mode	OFF	

CID Central Station Reporting Options

P170E	Central Station Reporting Number1	none	Refer to the separate Comms manual	
P171E	Central Station Reporting Number2	none		
P172E	Central Station Test Call Number	none		
P72E	Account No. 1 for Central Station rpt	0000		
P73E	Account No. 2 for Central Station rpt	0000		
P74E	REPORT ZONE ALARMS	All zones		
P75E	1E	Report DURESS alarms		OFF
	2E	Report MEDICAL alarms		OFF
	3E	Report keypad & Keyswitch PANIC		ON
	4E	Report FIRE alarms		OFF
	5E	Report PANEL TAMPER alarms		ON
	6E	Report EXTERNAL TAMPER alarms		ON
	7E	Report KEYPAD TAMPER alarms		ON
	8E	Report EXIT FROM INSTALLER mode		OFF
	9E	Report RADIO TAMPER	ON	
	10E	Report RADIO PANIC by User ID	ON	
	11E	Report RADIO Low Battery by device	OFF	
	12E	Report ZONE SUPERVISION FAIL	OFF	
	13E	Report PANEL LOW BATTERY	ON	
	14E	Report MAINS FAIL	ON	
P76E	Report Zone Restorals	All on		
P77E	Report Misc. Restorals	All on		
P78E	Report Multiple Zone alarms	NONE		
P79E	Account No.2 zones	NONE		
P82E	1E	Send RESTORAL report immediately	OFF	
	2E	Send RESTORAL after siren time	OFF	
	3E	Send RESTORAL after Disarm & seal	OFF	
	4E	Send RESTORAL after Disarm always	ON	
P83E	TEST CALL Interval	84 (168hrs)		
P84E	Time before NEXT TEST CALL			
P85E	Polling Interval	8=OFF		
P86E	1E	Disable Communicator	OFF	
	3E	Enable reporting by ARMOR IP	ON	
	5E	Enable reporting by CSV IP	OFF	
P87E*	1E	Split dial Primary/Secondary numbers	OFF	
	2E	[not used]	OFF	
SMS	3E	Enable reporting by SMS	ON	
	4E	4 Dialling attempts	ON	

OPTION	DESCRIPTION	DEFAULT	PAGE	
P88E	1E	Send AREA 1 Open/Close to Central Stn	OFF	Refer to the separate Comms manual
	2E	Send AREA 2 Open/Close to Central Stn	OFF	
		See P194E for Open/Close by SMS		
	3E	Siren Chirp on Kiss-off	OFF	
	4E	Flash Strobe on Kiss-off	OFF	
	5E	Forced Opening report	ON	
	6E	Delayed Closing Reports	OFF	
	7E	Manual Exclude Reports	ON	
P89E	1E	ENABLE TEST CALLS	ON	
	2E	Mains Report Delay (1 hour)	ON	
	3E	Enable SMS Test Report	OFF	
	4E	Swinger shutdown	ON	
	5E	Cellular Fault Monitor	ON	
	6E	Master Code Clears Reprt Attempts	OFF	

The following options relate to reporting Central Station reporting. See P191E, P193E for Misc Alarm reporting options via SMS.

P92E	Report Misc. Remote Alarms by CID		Refer to the separate Comms manual	
	5E	Remote Panel Tamper		ON
	13E	Remote Panel Low Battery		ON
	14E	Remote Panel Mains Fail		ON
P93E	Report Misc. Remote Restorals by CID		See the Comms manual	
	5E	Remote Panel Tamper		ON
	13E	Remote Panel Low Battery		ON
	14E	Remote Panel Mains Fail		ON
15E	Remote Panel Comms Fail	ON		

P94E	"No Memory Warning" zones	none	41
-------------	---------------------------	------	----

P95E	CLEAR RADIO DEVICES		42
P96E	CLEAR MEMORY		
P97E	CLEAR PANEL OPTIONS (restore Factory Defaults)		
P98E	CLEAR User codes, Radio Keys, Access Cards		
P99E	Program the INSTALLER CODE	000000	

P117E	1E	Enable Output Expander	OFF	43-45
	2E	Expander Output Format A, B	OFF	
	3E	Day Zone Follower	OFF	
	4E	Output Exclude	OFF	
	5E	Expander Output Format C, D	OFF	
	6E	User Code Toggle or Pulse	OFF	
P118E	Output Expander zones	none		
P119E	Output Expander alarm zones	none		
P120E	1E	Latched keyswitch input	OFF	46-47
	2E	Home arm chirps by radio key	OFF	
	3E	Radio Key AUX arms Home mode	OFF	
	4E	Keyswitch DISARM ONLY	OFF	
	5E	Keyswitch ARM ONLY	OFF	
	6E	Smart Beeps (Brief Home & Day modes)	OFF	
	7E	Entry Delay Extender	OFF	
	8E	Area2 Disarm by Keyswitch Allowed	OFF	

OPTION	DESCRIPTION	DEFAULT	PAGE
P121E	1E Zone alarms to AUX1 (P58E selects zones)	ON	48
	2E Zone Supervision alarms to AUX1	OFF	
	3E Radio key Panic TOGGLE	OFF	
	4E Radio key Panic PULSE	OFF	
	5E [not used]		
	6E [not used]		
	7E Door Open Too Long (DOTL) alarm to AUX1	OFF	
	8E Reader [x] output to AUX1	OFF	
P122E	1E Zone alarms to AUX2 (P59E selects zones)	ON	50
	2E Zone Supervision alarms to AUX2	OFF	
	3E Radio key Aux Button TOGGLE	OFF	
	4E Radio key Aux Button PULSE	OFF	
	5E [not used]	OFF	
	6E [not used]	OFF	
	7E Door Open Too Long (DOTL) alarm to AUX2	OFF	
	8E Reader [x] output to AUX2	OFF	
P123E	1E Zone Alarms to AUX3	OFF	52
	3E Enable AUX3 for AutoTime	OFF	
	4E Radio Key Panic Pulses AUX3	OFF	
	5E [not used]	OFF	
	6E [not used]	OFF	
	7E [not used]	OFF	
	8E Reader [x] output to AUX3	OFF	
	P124E	1E Zone Alarms to AUX4	
2E Enable Extension Sonalert		OFF	
3E Enable AUX4 for AutoTime		OFF	
4E Radio Key AUX Pulses AUX4		OFF	
5E [not used]		OFF	
6E [not used]		OFF	
7E [not used]		OFF	
8E Reader [x] output to AUX4		OFF	
P125E	Enable hardwired zones	All on	58
P126E	1E Enable Double key PANIC	ON	59
	2E Enable Double key FIRE	OFF	
	3E Enable Dbl key MEDICAL & Nav MEDICAL	OFF	
	4E Enable Entry Chime, DAY Mode	OFF	
	5E Enable Entry Chime, HOME Mode	OFF	
	6E [not used]	OFF	
	7E [not used]	OFF	
	8E Disable One Digit At A Time display	ON	
P129E	1E 0k EOL resistors	OFF	59
	2E 1k EOL resistors	OFF	
	3E 1.5k EOL resistors	OFF	
	4E 2.2k EOL resistors	ON	
	5E 3.3k EOL resistors	OFF	
	6E 3.9k EOL resistors	OFF	
	7E 4.7k EOL resistors	OFF	
	8E 5.6k EOL resistors	OFF	
	9E 6.8k EOL resistors	OFF	
	10E 8.2k EOL resistors	OFF	
	11E 10k EOL resistors	OFF	
	12E 12k EOL resistors	OFF	
	13E 22k EOL resistors	OFF	

OPTION	DESCRIPTION	DEFAULT	PAGE
P141E	1E Area 1 Armed to AUX1	OFF	49
	2E Area 2 Armed to AUX1	OFF	
	3E Home Armed to AUX1	OFF	
	4E Keypad toggles AUX1	OFF	
	8E Pulse AUX1	OFF	
P142E	1E Area 1 Armed to AUX2	OFF	51
	2E Area 2 Armed to AUX2	OFF	
	3E Home Armed to AUX2	OFF	
	4E Keypad toggles AUX2	OFF	
P143E	1E Area 1 Armed to AUX3	OFF	53
	2E Area 2 Armed to AUX3	OFF	
	3E Home Armed to AUX3	OFF	
	4E Keypad toggles AUX3	OFF	
P144E	1E Area 1 Armed to AUX4	OFF	55
	2E Area 2 Armed to AUX4	OFF	
	3E Home Armed to AUX4	OFF	
	4E Keypad toggles AUX4	OFF	
P145E	AUX1 Timer (1-99 sec)	20 sec	49
P146E	AUX2 Timer (1-99 sec)	20 sec	51
P147E	AUX3 Timer (1-99 sec)	20 sec	53
P148E	AUX4 Timer (1-99 sec)	20 sec	55
P151E	4E Keypad toggles AUX5	OFF	56
	5E [not used]	OFF	
	7E Reader Output to AUX5	OFF	
	8E PULSE AUX5	OFF	
P152E	2E AUX+ * key Toggles AUX6	OFF	56
	3E AUX+ * key Pulses AUX6	OFF	
	4E Keypad toggles AUX6	OFF	
P153E	7E Reader Output to AUX6	OFF	57
	8E PULSE AUX6	OFF	
	4E Keypad toggles AUX7	OFF	
	5E [not used]	OFF	
P154E	7E Reader Output to AUX7	OFF	57
	8E PULSE AUX7	OFF	
	2E AUX+ * key Toggles AUX8	OFF	
	3E AUX+ * key Pulses AUX8	OFF	
P155E	4E Keypad toggles AUX8	OFF	58
	7E Reader Output to AUX8	OFF	
	8E PULSE AUX8	OFF	
	P156E	AUX5 timer	
P157E	AUX6 timer	20 sec	
P158E	AUX7 timer	20 sec	
P160E	AUX8 timer	20 sec	
P161E	Alarm Siren Volume	99	58
P162E	Fire Siren Volume	99	
P162E	Chirp Siren Volume	16	

*Aux+ is button 4 on the RK5 radio key



PROGRAMMING OPTIONS TABLE

Summary of all program options for Panel & Comms.
Also refer to the separate **DPlus Comms Manual**

OPTION	DESCRIPTION	DEFAULT	PAGE
SMS SMS Reporting Options			
P180E SMS	U Ph No 1 for SMS alarm reports	none	
P181E SMS	U Ph No 2 for SMS alarm reports	none	
P182E SMS	U Ph No 3 for SMS alarm reports	none	
P183E SMS	U Ph No 4 for SMS Area1 O/C reports	none	
P184E SMS	U Ph No 5 for SMS Area2 O/C reports	none	
P185E SMS	U Ph No 6 for SMS operation	none	
P186E SMS	U Ph No 7 for SMS operation	none	
P187E SMS	U Ph No 8 for SMS operation	none	
P188E SMS	U Ph No 9 for SMS operation	none	
P189E SMS	U Ph No 10 for SMS operation	none	
P190E SMS	Report Zone Alarms by SMS	All on	
P191E SMS	Report Misc Alarms by SMS	See page	
P192E SMS	Report Zone Restorals by SMS	All on	
P193E SMS	Report Misc Restorals by SMS	All on	
P194E SMS	1E Send AREA 1 Open/Close by SMS	OFF	
P194E SMS	2E Send AREA 2 Open/Close by SMS	OFF	
P195E SMS	SMS Test Report Status includes:		
P195E SMS	1E Zones unsealed	OFF	
P195E SMS	2E Zones in alarm	OFF	
P195E SMS	3E Zones excluded	OFF	
P195E SMS	4E Zones Supervision fail	OFF	
P195E SMS	5E Zones doors open	OFF	
P195E SMS	6E Zones detector low battery	OFF	
P195E SMS	7E Zones detector tamper	OFF	
P195E SMS	8E Miscellaneous alarms	ON	
P195E SMS	9E Arming status	OFF	
P195E SMS	10E Outputs on	OFF	
P195E SMS	11E Model and version	OFF	
P195E SMS	12E Aux Outputs on	OFF	
P196E SMS	Report Misc. Remote Alarms by SMS		
P196E SMS	5E Remote Panel Tamper alarm	OFF	
P196E SMS	13E Remote Panel Low Batt alarm	OFF	
P196E SMS	14E Remote Panel Mains Fail alarm	OFF	
P196E SMS	15E Remote Panel Comms Fail alarm	OFF	
P197E SMS	RESTORALS VIA SMS		
P197E SMS	5E Remote Panel Tamper restoral	OFF	
P197E SMS	13E Remote Panel Low Batt restoral	OFF	
P197E SMS	14E Remote Panel Mains Fail restoral	OFF	
P197E SMS	15E Remote Panel Comms Fail restoral	OFF	
P199E	Serial Output Options 1E-7E Enable 1E-7E to enable operation via optional Ness-Bridge interface.	All off	66

Refer to the separate Comms manual

ACCESS CONTROL OPTIONS

P300E	DEFAULT ALL ACCESS CONTROL OPTIONS		68
--------------	------------------------------------	--	----

OPTION	DESCRIPTION	DEFAULT	PAGE
P301E 1E	Use reader addresses	OFF	69
2E	Arm with double read	ON	
3E	Arm with single read and pushbutton	OFF	
4E	Disarm with access card	ON	
5E	REX Input 1 (Zone 5 input)	OFF	
6E	REX Input 2 (Zone 6 input)	OFF	
7E	REX Input 3 (Zone 7 input)	OFF	
8E	Strobe Flash on Arm/Disarm by Reader	ON	
P303E	DOTL zones	none	70-71
P304E	DOTL time	20 sec	
P305E 1E	DOTL output LATCHES	OFF	
2E	DOTL outputs to Output Expander	OFF	
3E	DOTL Timer in Minutes	OFF	
4E	DOTL Timer in Hours	OFF	
5E	DOTL zone flashes on keypad	OFF	

AUX OUTPUTS

P318E 1E	Ultraprox Reader 1 to AUX1	OFF	72
2E	Ultraprox Reader 1 to AUX2	OFF	
3E	Ultraprox Reader 1 to AUX3	OFF	
4E	Ultraprox Reader 1 to AUX4	OFF	
5E	Ultraprox Reader 1 to AUX5	OFF	
6E	Ultraprox Reader 1 to AUX6	OFF	
7E	Ultraprox Reader 1 to AUX7	OFF	
8E	Ultraprox Reader 1 to AUX8	OFF	
P319E	Ultraprox Reader 1 output TIME	5 sec	
P328E 1E	Ultraprox Reader 2 to AUX1	OFF	
2E	Ultraprox Reader 2 to AUX2	OFF	
3E	Ultraprox Reader 2 to AUX3	OFF	
4E	Ultraprox Reader 2 to AUX4	OFF	
5E	Ultraprox Reader 2 to AUX5	OFF	
6E	Ultraprox Reader 2 to AUX6	OFF	
7E	Ultraprox Reader 2 to AUX7	OFF	
8E	Ultraprox Reader 2 to AUX8	OFF	
P329E	Ultraprox Reader 2 output TIME	5 sec	
P338E 1E	Ultraprox Reader 3 to AUX1	OFF	
2E	Ultraprox Reader 3 to AUX2	OFF	
3E	Ultraprox Reader 3 to AUX3	OFF	
4E	Ultraprox Reader 3 to AUX4	OFF	
5E	Ultraprox Reader 3 to AUX5	OFF	
6E	Ultraprox Reader 3 to AUX6	OFF	
7E	Ultraprox Reader 3 to AUX7	OFF	
8E	Ultraprox Reader 3 to AUX8	OFF	
P339E	Ultraprox Reader 3 output TIME	5 sec	

U REAL TIME CLOCK options can be programmed in User Program Mode.

P340E	Real Time Clock set MINUTES	00 (00-59)	61
P341E	Real Time Clock set HOURS	00 (00-23)	
P342E	Real Time Clock set DAY	01 (01-31)	
P343E	Real Time Clock set MONTH	01 (01-12)	
P344E	Real Time Clock set YEAR	2024	
P345E	Real Time Clock view DAY of week		

P401E to P432E	Program Radio Devices 1 to 32		64
------------------------------------	-------------------------------	--	----

*SMS & Central Station reporting requires the optional 106-985 4G Module



Summary of all program options for Panel & Comms.
Also refer to the separate **DPlus Comms Manual**

OPTION	DESCRIPTION	Default
AutoTimer 1		
P350E	Minutes 0-59	
P351E	Hours 0-23	
P352E	Days (1=Sunday)	
P353E	1E AREA 1 arm	
	2E AREA 2 arm	
	3E HOME arm	
	4E Code Enable	
	5E Code Disable	
	6E KEYPAD Beeps	
	7E RESET O/P Beeps	
	8E Extend AutoTIME	
P354E	1E AREA 1 disarm	
	2E AREA 2 disarm	
	3E HOME disarm	
	4E Uses AUX5&6 not AUX1&2	
	5E AUX1 TOGGLE	
	6E AUX1 PULSE	
	7E AUX2 TOGGLE	
	8E AUX2 PULSE	

OPTION	DESCRIPTION	Default
AutoTimer 4		
P365E	Minutes 0-59	
P366E	Hours 0-23	
P367E	Days (1=Sunday)	
P368E	1E AREA 1 arm	
	2E AREA 2 arm	
	3E HOME arm	
	4E Code Enable	
	5E Code Disable	
	6E KEYPAD Beeps	
	7E RESET O/P Beeps	
	8E Extend AutoTIME	
P369E	1E AREA 1 disarm	
	2E AREA 2 disarm	
	3E HOME disarm	
	4E Uses AUX5&6 not AUX1&2	
	5E AUX1 TOGGLE	
	6E AUX1 PULSE	
	7E AUX2 TOGGLE	
	8E AUX2 PULSE	

OPTION	DESCRIPTION	Default
AutoTimer 7		
P380E	Minutes 0-59	
P381E	Hours 0-23	
P382E	Days (1=Sunday)	
P383E	1E AREA 1 arm	
	2E AREA 2 arm	
	3E BRIEF DAY MODE arm	
	4E Code Enable	
	5E Code Disable	
	6E KEYPAD Beeps	
	7E RESET O/P Beeps	
	8E Extend AutoTIME	
P384E	1E AREA 1 disarm	
	2E AREA 2 disarm	
	3E BRIEF DAY MODE disarm	
	4E Uses AUX7&8 not AUX3&4	
	5E AUX3 TOGGLE	
	6E AUX3 PULSE	
	7E AUX4 TOGGLE	
	8E AUX4 PULSE	

OPTION	DESCRIPTION	Default
AutoTimer 2		
P355E	Minutes 0-59	
P356E	Hours 0-23	
P357E	Days (1=Sunday)	
P358E	1E AREA 1 arm	
	2E AREA 2 arm	
	3E HOME arm	
	4E Code Enable	
	5E Code Disable	
	6E KEYPAD Beeps	
	7E RESET O/P Beeps	
	8E Extend AutoTIME	
P359E	1E AREA 1 disarm	
	2E AREA 2 disarm	
	3E HOME disarm	
	4E Uses AUX5&6 not AUX1&2	
	5E AUX1 TOGGLE	
	6E AUX1 PULSE	
	7E AUX2 TOGGLE	
	8E AUX2 PULSE	

OPTION	DESCRIPTION	Default
AutoTimer 5		
P370E	Minutes 0-59	
P371E	Hours 0-23	
P372E	Days (1=Sunday)	
P373E	1E AREA 1 arm	
	2E AREA 2 arm	
	3E HOME arm	
	4E Code Enable	
	5E Code Disable	
	6E KEYPAD Beeps	
	7E RESET O/P Beeps	
	8E Extend AutoTIME	
P374E	1E AREA 1 disarm	
	2E AREA 2 disarm	
	3E HOME disarm	
	4E Uses AUX7&8 not AUX3&4	
	5E AUX3 TOGGLE	
	6E AUX3 PULSE	
	7E AUX4 TOGGLE	
	8E AUX4 PULSE	

OPTION	DESCRIPTION	Default
AutoTimer 8		
P385E	Minutes 0-59	
P386E	Hours 0-23	
P387E	Days (1=Sunday)	
P388E	1E AREA 1 arm	
	2E AREA 2 arm	
	3E BRIEF DAY MODE arm	
	4E Code Enable	
	5E Code Disable	
	6E KEYPAD Beeps	
	7E RESET O/P Beeps	
	8E Extend AutoTIME	
P389E	1E AREA 1 disarm	
	2E AREA 2 disarm	
	3E BRIEF DAY MODE disarm	
	4E Uses AUX7&8 not AUX3&4	
	5E AUX3 TOGGLE	
	6E AUX3 PULSE	
	7E AUX4 TOGGLE	
	8E AUX4 PULSE	

OPTION	DESCRIPTION	Default
AutoTimer 3		
P360E	Minutes 0-59	
P361E	Hours 0-23	
P362E	Days (1=Sunday)	
P363E	1E AREA 1 arm	
	2E AREA 2 arm	
	3E HOME arm	
	4E Code Enable	
	5E Code Disable	
	6E KEYPAD Beeps	
	7E RESET O/P Beeps	
	8E Extend AutoTIME	
P364E	1E AREA 1 disarm	
	2E AREA 2 disarm	
	3E HOME disarm	
	4E Uses AUX5&6 not AUX1&2	
	5E AUX1 TOGGLE	
	6E AUX1 PULSE	
	7E AUX2 TOGGLE	
	8E AUX2 PULSE	

OPTION	DESCRIPTION	Default
AutoTimer 6		
P375E	Minutes 0-59	
P376E	Hours 0-23	
P377E	Days (1=Sunday)	
P378E	1E AREA 1 arm	
	2E AREA 2 arm	
	3E HOME arm	
	4E Code Enable	
	5E Code Disable	
	6E KEYPAD Beeps	
	7E RESET O/P Beeps	
	8E Extend AutoTIME	
P379E	1E AREA 1 disarm	
	2E AREA 2 disarm	
	3E HOME disarm	
	4E Uses AUX7&8 not AUX3&4	
	5E AUX3 TOGGLE	
	6E AUX3 PULSE	
	7E AUX4 TOGGLE	
	8E AUX4 PULSE	

AUTOTIMER RELATED OPTIONS

OPTION	DESCRIPTION	Default
P390E	AutoTime warning (1-99 min)	00
P392E 1E	AutoTime codes Option	OFF
P121E 3E	Enable AUX1 for AutoTimers	OFF
P122E 3E	Enable AUX2 for AutoTimers	OFF
P123E 3E	Enable AUX3 for AutoTimers	OFF
P124E 3E	Enable AUX4 for AutoTimers	OFF
P145E	AUX1 Pulse Time (1-99 sec)	20 sec
P146E	AUX2 Pulse Time (1-99 sec)	20 sec
P147E	AUX3 Pulse Time (1-99 sec)	20 sec
P148E	AUX4 Pulse Time (1-99 sec)	20 sec

See pages 60-62 for descriptions of AutoTimer related options.

106-981-P
CONTROL PANEL PACKING LIST

- 1 DPlus Main board
- 1 Housing
- 1 20VDC Power supply (Australia only)
- 1 12V 7Ah battery (Australia only)
- 1 User manual
- 1 Installer manual
- 9 End Of Line resistors 2.2k
- 1 Lead assembly for battery
- 1 Lead assembly for internal tamper
- 2 Housing cover screws
- 4 Circuit board supports

SPECIFICATIONS

POWER REQUIREMENTS		17VAC or 20VDC
QUIESCENT CURRENT DRAW		80mA with 1 keypad.
RECHARGEABLE BATTERY		12 volt 7.0 Amp/hour Sealed Lead Acid.
BATTERY CHARGING CURRENT		350mA maximum, current limited.
DYNAMIC BATTERY TEST		Backup battery is tested under load, hourly and on arming.
FUSES		2 Amp auto resetting / Siren output & Reset output. 500mA auto resetting / 12 volt auxiliary outputs. 200 mA auto resetting / strobe output.
4G MODULE (OPTIONAL)		Multi-Band LTE-TDD/ LTE-FDD/HSPA+/GSM/GPRS/EDGE B1 (2100)/B3(1800)/B7(2600)/B8(900)/B5(850)/B28(700 APAC) Standard SIM
ZONES		8 or 16 zone inputs. 2 x 24hr tamper inputs.
END OF LINE RESISTOR		Default 2200 Ohms (2.2k). Other values programmable.
KEYPADS - COMPATIBILITY		KPX+ V2.00 or later SATURN+ V2.00 or later NAVIGATOR V4.00 or later
MAXIMUM KEYPADS		Maximum 3x mixed keypads or 4x Navigator keypads per system
RECEIVER HEADER		Connection for Ness One Way Radio Interface or Two Way Radio Interface.
AUX HEADER		Multi-pin connector provides: Outputs Aux1, Aux2, Aux3, Aux4, 12V DC and connection for optional output expander/s.
SERIAL HEADER		Serial data port for optional Ness-Bridge ethernet module or direct connect programming using NessComms™ software.
READER HEADER		Multi-pin port for connecting up to 3 Ness proximity access card readers.
COMMUNICATION EXPANDER		Multi-pin port for optional 4G Module
ZONE EXPANDER		Multi-pin port for optional L16 or L24 Hardwired Zone Expander.
SIREN		On board siren driver with timed output. Maximum 3 x 8 Ohm horn speakers.
STROBE		12V DC timed output. Maximum 2 x 1 Watt strobe lights.
RESET		12V DC timed output. Maximum 3 x 12V piezo screamers.
EQUIPMENT POWER OUTPUT		13.8V DC output for powering detectors and other equipment. Maximum 500mA.
DIMENSIONS	PLASTIC HOUSING	235w x 300h x 90d mm
	CARTON	330w x 310h x 105d mm
CARTON WEIGHT (Plastic Housing)		~ 4kg including plug pack and battery



RELEASE NOTES

DPlus Installation Manual

Rev 1.14 Apr26

Fixed minor typos on program options summary pages

Rev 1.13 Jun25

- P56, P152E 2E RK5 radio key AUX+ Button 4 (not Button 5) toggles AUX6.
- P50, P122E 4E Radio Key/s AUX button **3** will PULSE the Aux2 output.

- P75 Deleted P86E 2E report by CID, added P86E 5E report by CSV IP
See the separate Comms Manual for details on reporting formats.

- Various images improved

Rev 1.12 Sep24

- P32 fixed typos

Rev 1.1 Sep24

- P60E 7E Disable Keypad display, LCD keypads now turn off display and keys backlighting

Rev 1.0 Aug24

First release

DPLUS REVISIONS

FIRMWARE	Production Date	Comms Options	How many SMS Phone numbers?	Monitoring Protocols
Rev 1.0	August 2024	Optional 106-985 4G Module Optional 106-014 Ethernet Module	5 (3 alarm, 2 open/close)	SMS Self Monitoring ARMOR IP Back-To-Base CSV IP Back-To-Base



HOW TO DISPLAY THE FIRMWARE VERSION

By Keypad, in User or Installer program mode, press P 99999999 E (eight 9's)

By SMS, send the command: i [Master Code] E MOD

REFERENCE

ENTERING PROGRAM DATA IN HEXADECIMAL FORMAT

DPlus program data is normally entered in Decimal format. Hex is optional for some program options.

ENTERING HEX DATA USING

NAVIGATOR KEYPAD

Navigator keypad provides buttons for entering Hex digits B, C, D, E, F in the options

P02E, optional (Installation manual)
P03E, optional (Installation manual)
P72E, optional (Comms Manual)

HEX ACCOUNT NUMBERS USING KPX+ KEYPAD

Central station client codes can be entered in Hexadecimal as required by some central stations. Use the following keys to enter the hex digits B, C, D, E or F.

HEX DIGIT	KPX+ KEY	DISPLAYED AS
B	* Key	11
C	ARM Key	12
D	HOME Key	13
E	EXCLUDE Key	14
F	MEMORY key	15

INSTALLATION RECORD



- P26E ENTRY DELAY TIME 1
- P27E ENTRY DELAY TIME 2
- P28E EXIT DELAY TIME
- P29E SIREN RESET TIME

DATE PURCHASED:	DATE INSTALLED:
INSTALLATION COMPANY:	
TELEPHONE:	
MONITORING COMPANY:	
TELEPHONE:	

	Seconds
	Seconds
	Seconds
	Minutes

- ZONE ASSIGNMENT**
- P41E ENTRY DELAY 1
 - P43E ENTRY DELAY 2
 - P42E HANDOVER
 - P40E INSTANT
 - P45E AREA 1
 - P46E AREA 2
 - P51E HOME MODE
 - P52E 24 HOUR
 - P54E RESET OUTPUT
 - P55E STROBE OUTPUT
 - P56E SONALERT OUTPUT
 - P57E SIREN OUTPUT
 - P74E Report (dialler)

ZONES	DEVICE TYPE	PIR, Reed switch, etc	DESCRIPTION	Entrance, bedroom1, etc	P41E	P43E	P42E	P40E	P45E	P46E	P51E	P52E	P54E	P55E	P56E	P57E	P74E
1																	
2																	
3																	
4																	
5																	
6																	
7																	
8																	
9																	
10																	
11																	
12																	
13																	
14																	
		... optional, up to 32 zones															
32																	

USER CODE	OPTION No	Extra Options Assigned E.g. Radio Code, Arm Only, etc.
1	Master Code	P201E
2		P202E
3		P203E
4		P204E
5		P205E
6		P206E
7		P207E
8		P208E
9		P209E
10		P210E
11		P211E
12		P212E
13		P213E
14		P214E
15		P215E
16		P216E
17		P217E
18		P218E
19		P219E

USER CODE	OPTION No	Extra Options Assigned E.g. Radio Code, Arm Only, etc.
20		P220E
21		P221E
22		P222E
23		P223E
24		P224E
25		P225E
26		P226E
27		P227E
28		P228E
29		P229E
30		P230E
31		P231E
32		P232E
33		P233E
34		P234E
35		P235E
36		P236E
37		P237E
38		P238E

USER CODE	OPTION No	Extra Options Assigned E.g. Radio Code, Arm Only, etc.
39		P239E
40		P240E
41		P241E
42		P242E
43		P243E
44		P244E
45		P245E
46		P246E
47		P247E
48		P248E
49		P249E
50		P250E
51		P251E
52		P252E
53		P253E
54		P254E
55		P255E
56		P256E

